

RADIO

ESTABLISHED 1917



DIATHERMY
PP 13

THIS MONTH:
Controlled Carrier Grid Modulation
•
A New All-Band Antenna System
•
An Improved Method of A.V.C.
•
High Efficiency Doubling Circuits
•
Metal Tube Mike Preamplifiers
•
Constructing Diathermy Apparatus
•
Economical 10 Meter Phone-C.W.
•
New Twisted Pair Feeder Data

April, 1936 — No. 208

30c in U.S.A. and Canada

1/8 in the United Kingdom
2/- in Australasia

★★★ World's Fastest Sales Growth

BECAUSE: *World's Most Beautiful Refrigerator*

**PLUS THIS MUCH MORE
IN A SHELVADOR !!**

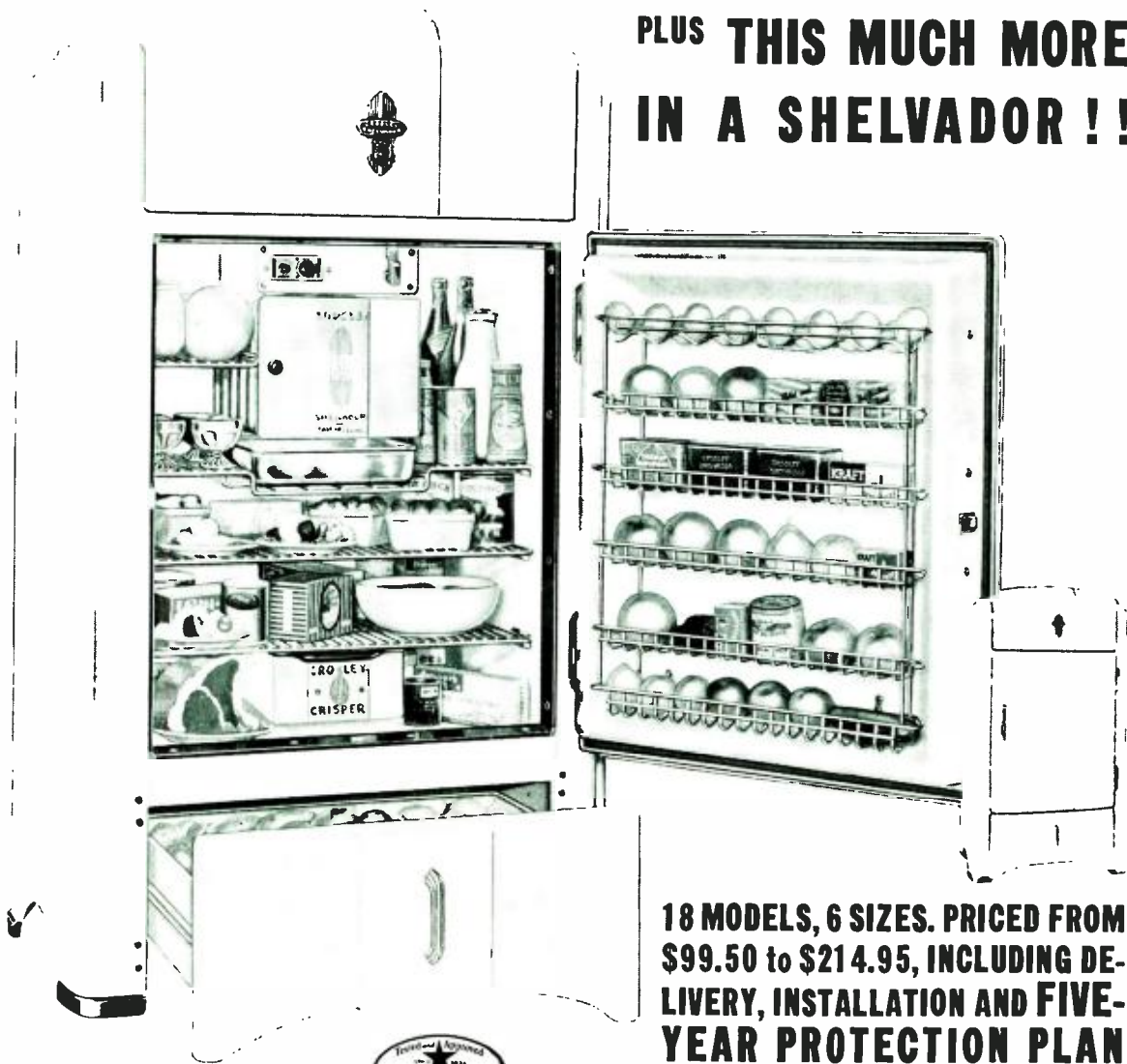

**18 MODELS, 6 SIZES. PRICED FROM
\$99.50 to \$214.95, INCLUDING DE-
LIVERY, INSTALLATION AND FIVE-
YEAR PROTECTION PLAN**

*All prices slightly higher in Florida, Texas, Rocky
Mountain states and West*



CROSLY

THE CROSLY RADIO CORPORATION, CINCINNATI - POWEL CROSLY, Jr., President

Another Great EIMAC Achievement . . .

EIMAC 35T

Answering the incessant demand for a quality transmitting tube for the low power man, EIMAC is proud to present for your approval the EIMAC 35T.

The EIMAC 35T employs the now internationally famous EIMAC construction which embodies the following features:

- Plate and grid fabricated from TANTALUM (No getter necessary or desirable to maintain proper vacuum)
- Plate terminal at top of envelope.
- Extremely low interelectrode capacities
- No internal insulators to break down or cause power loss.
- Vertical bar grid (Unique design permits definite savings in grid power)
- Rugged thoriated tungsten filament
- Hard glass bulb. (Nonex glass permits maximum safe heat dissipation making possible the small physical size of the EIMAC 35T)



EIMAC 35T
Actual Size

The EIMAC 35T has electrical characteristics that make it ideally suited for use as an oscillator; R.F. Amplifier, doubler, and class "B" audio tube.

CHARACTERISTICS

Filament voltage.....	5 volts
Filament current.....	4 amperes
Amplification factor.....	30
Maximum plate current.....	100 milliamperes
Plate voltage.....	200-1500 volts
Plate dissipation.....	35 watts
Grid-plate capacity.....	2 mmfd.
Base.....	Standard UX-4 prong
Height—Overall	5½ inches
Maximum diameter.....	1¾ inches

PERFORMANCE

Plate Voltage	Class "C" R.F. (75% eff.)	Class "B" Audio (two tubes)
500 volts	38 watts	50 watts
750 volts	56 watts	80 watts
1000 volts	75 watts	115 watts
1250 volts	94 watts	135 watts
1500 volts	112 watts	150 watts

The EIMAC 35T will be available at leading dealers after April 15

NET PRICE \$8.00

EITEL-McCULLOUGH, INC.

SAN BRUNO, CALIFORNIA
U. S. A.

CABLE "EIMAC"

Build Your Own ALL-STAR TRANSMITTER

Below — Rear view of 400-watt Phone Transmitter.

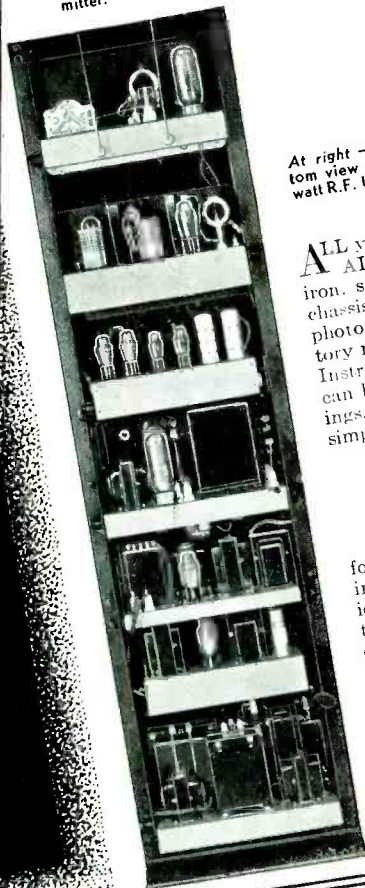

At right — Bottom view of 40-watt R.F. Unit.

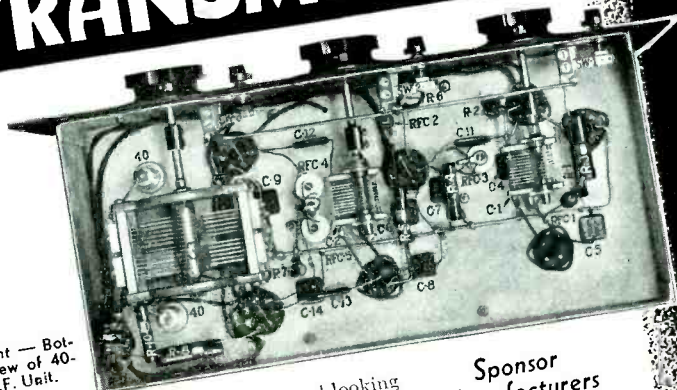

ALL you need to build this professional-looking ALL-STAR TRANSMITTER is a soldering iron, screw driver and a pair of pliers. Drilled chassis and detailed instructions, including photographs, enable you to duplicate the laboratory results. No laborious drilling or machining. Instructions are so explicit and complete the job can be done without using the schematic drawings. Yet, efficiency has not been sacrificed to simplify construction.

Photographs and Diagrams Accurately Guide You

Instruction Sheet, which is provided with each foundation unit, contains 21 photographs showing in detail the standard parts used. Each part is identified by a key-number for quick, easy identification. Besides the photographs, there are eight diagrams, one for each unit and one for the complete unit.

Nothing Discarded!

Build step by step the various units without discarding anything from previous stages. If you own a suitable low-power unit, you can add the ALL-STAR High Power stages and complete the 400 or 500-watt jobs. Or if you already have a CW transmitter, the speech amplifier and modulator can be added for phone operation.

Build in Easy Steps Save \$200 to \$300

Complete 40-watt CW transmitter — 40-watt phone transmitter — 500-watt CW transmitter — or 400-watt phone — can be built at savings up to \$300 over a factory-built transmitter of equal appearance and performance. Foundation units and all the STANDARD parts required to build any or all ALL-STAR TRANSMITTER units are stocked by local supply dealers. Complete constructional data and diagrams, 25¢ postpaid, or FREE with foundation units.

Sponsor Manufacturer

THORDARSON ELEC. MFG. CO.
500 W. Huron St.
Chicago

HAMMARLUND MFG. CO.
424 W. 33d St., New York
CORNELL-DUBILIER CORP.

4377 Bronx Blvd.
New York
TRIPLETT ELEC. INST. CO.

Bluffton, O.
OHMITE MFG. CO.
4829 W. Flournoy St.
Chicago

E. F. JOHNSON CO.
Waseca, Minn.
CROWE NAME PLATE MFG. CO.
1749 Grace St., Chicago

BUILD YOUR OWN ★
ALL-STAR
TRANSMITTER

See Your Jobber or Write to any of the sponsor-manufacturers listed, or to ALL-STAR HEADQUARTERS, 222 W. Adams St., Chicago.



The publishers assume no responsibility for statements made herein by contributors and correspondents, nor does publication indicate approval thereof.

CONTENTS

With the Editors	7
A Controlled Carrier, Grid Modulated Phone— <i>Frank C. Jones</i>	8
Diathermy Construction— <i>Faust Gonsett, W6VR</i>	13
Getting the Most from the Twisted Pair— <i>Robert C. Graham</i>	18
High Efficiency Frequency Doublers— <i>E. M. Dowling</i>	23
Some Notes on Grid Excitation—"Jayenay"	29
Metal Tube Microphone Amplifiers— <i>Maurice E. Kennedy, W6BGC</i>	32
28 and 56 Megacycle Activity	35
A Relay Rack at Low Cost— <i>D. Reginald Tibbetts, W6ITH</i>	38
A Multiband Single-Wire-Fed Antenna— <i>Frank C. Jones</i>	42
The Noise Reduction Problem— <i>Robert S. Kruse</i>	44
More Effective Automatic Gain Control— <i>Franklin Offner, W9FTO</i>	46
Putting the 35-T to Work	50
R.F. Interstage Coupling Methods— <i>J. N. A. Hawkins</i>	52
An Economical 10 Meter Phone-C.W. Rig— <i>Frank C. Jones</i>	58
Calls Heard	60
DX Department	62
Remote Controlled Band Switching— <i>Grant Corby, W6CIN</i>	64
A Dual-Frequency Crystal Calibrator	67
"But Not For Voice"— <i>Robert S. Kruse</i>	68
Simple Volume Range Expansion—"Jayenay"	70
An Effective, Inexpensive Keying Monitor— <i>William F. Jackson</i>	72
What's New	92

"RADIO" CONTRIBUTIONS

Contributions to our editorial pages are always welcome; though they will be handled with due care we assume no responsibility for those which are unsolicited; none will be returned unless accompanied by a stamped, addressed envelope. We do not suggest subjects on which to write; cover those you know best; upon request, we will comment on detailed outlines of proposed articles, but without committing ourselves to accept the finished manuscript.

Since we regard current "chiseling" policies as decidedly unfair, a small payment will be made, usually upon publication, for accepted material of a technical or constructional nature. Freehand, pencilled sketches will suffice. Good photographs add greatly to any article; they can easily be taken by the layman under proper instructions. For further details regarding the taking of photographs and the submission of contributions see "Radio" for January, 1936, or send stamp for a reprint.



Phone: Whitney 9615
Published by Radio, Ltd.

RADIO

Cable address:
Radiopubs, Los Angeles

7460 BEVERLY BOULEVARD
LOS ANGELES

Direct all correspondence to the home office at
Los Angeles except as otherwise requested.

Eastern Business Office:
500 Fifth Avenue, New York
Phone: CHickering 4-6218

Chicago Advertising Office:
3618 No. Bernard St.
Tel. JUNiper 5575

New York Circulation Office:
253 West 128th St.
Tel. MONument 2-2812

**Eastern Editorial Office:
and Laboratory: Great Hill Rd.
Guilford, Connecticut**

Rates and Notices

Single Copy Rates

On newsstands:

30c in U.S.A. and Canada
1/8 in the United Kingdom
2/- in Australia and New Zealand

By mail, postpaid from home office:

30c in U.S.A., Canada, and all countries
which take the \$2.50 subscription
rate; back copies, 5c extra.
40c elsewhere; no extra charge for back
copies when available.

(These rates do not apply to annual or other
special issues)

Subscription Rates

**U.S.A.* (and possessions), Canada, An-
dorra, Argentina, Bolivia, Brazil,
Chile, Columbia, Costa Rica, Cuba,
Dominican Republic, Ecuador, Guate-
mala, Haiti, Honduras, Mexico, New-
foundland, Nicaragua, Panama, Para-
guay, Peru, Salvador, Spain (and 1 Year 2 Years
possessions), Uruguay, and Venezuela;**
duties, if any, not included..... **\$2.50* \$4.00***

Elsewhere, duties, if any, not included 3.25 5.50

*In California, add 3% sales tax.

FREQUENCY

Published monthly under date as of the following
month; ten issues yearly including special annual
number; the August and September issues (which
would normally appear in July and August) are omit-
ted. Short-term subscriptions are accepted pro-rata,
but no special numbers will be included.

Terms and Remittances

Terms, strictly cash or equivalent with order. All
foreign and territorial remittances must be payable
at par in U.S.A. or Canadian funds or at current ex-
change in British funds. Cash, stamps, "bearer in-
struments", etc., are at sender's risk. Gummed, un-
used U. S. postage stamps accepted in small amounts;
3c denomination preferred.

Back Copies

Subscriptions cannot be started with back issues.
Back copies, if available, will be supplied from the
home office at single copy rates above.

Changes of Address

Notice of change of address must *reach* us by the first
of month preceding nominal date of issue with which
it is to become effective. We will not supply back
issues nor pay forwarding postage because of failure
to receive such advance notice.

Advertising

Advertising is accepted only at terms stated on our
current Advertising Rate Card which will be sent on
request to the Los Angeles or New York offices. For
classified advertising, see classified section of any
issue.

PRINCIPAL FOREIGN AGENTS

Canada: John A. Holmes, 815 W. Hastings Street,
Vancouver, B. C.

Europe: N. E. Read, 37, Willow Street, Oswestry,
Shropshire, England.

Australasia: "The Bulletin," Box 2521BB, Sydney.

The Staff

Technical and Editorial Department

Editor

W. W. SMITH, W6BCX

Associate Editor

K. V. R. LANSINGH, W6QX

Engineering Editors

FRANK C. JONES, W6AJF

ROBERT S. KRUSE,¹ W1FG

J. N. A. HAWKINS, W6AAR

Assistant Editors

HERBERT BECKER, W6QD

GEORGE D. WALKER,² W4CTO

E. H. CONKLIN,⁴ W9FM

CHARLES A. HILL, W6BRO

RUFUS P. TURNER,³ W1AY

Technical Consultants

RALPH O. GORDON, W6CLH

JAMES M. SHARP, JR., W6DMY

CHARLES D. FERRINE, JR., W6CUH

Laboratorian

FAUST GONSETT, W6VR

Laboratory Assistants

RAYMOND DAWLEY, W6DHG

MARTIN A. BROWN, W6ABF

JACK HARWOOD, W6DJZ

LOUIS E. TOTH, W1BNR

Technical Draftsmen

M. S. DAVIS

WILLIAM ROBERTS, W3BOI

Photographer

ROBERT NELSON

Editorial Secretary

D. O. WORTHINGTON

Business Department

Publisher

K. V. R. LANSINGH

Managing Editor

M. Q. HAURET

Circulation Manager

B. L. HOVER

Eastern Manager

V. R. LANSINGH

Correspondence and Manuscripts

Address all correspondence and manuscripts to the
home office at Los Angeles except as follows:

1. Technical and constructional manuscripts and
relevant correspondence from east of the Missis-
sippi River which may be sent to R. S. Kruse¹.
2. *Radioddities, Strays*, and the like may be sent to
Rufus P. Turner³.
3. Calls Heard may be sent to George Walker²;
also dx news and station descriptions from east-
ern America and from transatlantic countries.

Unusable, unsolicited manuscripts will be destroyed
unless accompanied by a stamped, addressed envelope.

Copyright, 1936. All rights reserved.

Reproduction without permission is forbidden; permission
is usually granted amateur radio papers on request.

Printed in U.S.A. by

GLENDALE PRINTERS, GLENDALE, CALIFORNIA

¹RADIO Laboratory, Great Hill Road, Guilford, Connecticut
²Box 355, Winston-Salem, North Carolina.
³159 W. Springfield Street, Boston, Massachusetts.
4512 N. Main St., Wheaton, Illinois.

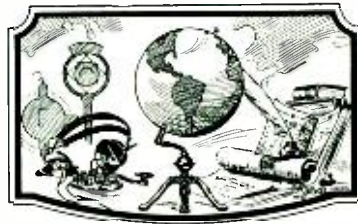

They Can No Longer Dodge

Biennially the late president of the American Radio Relay League requested that he be replaced by a younger man. Biennially the board fluttered and didn't know what to do but re-elect him.

Now the Board cannot dodge. The President's last resignation was countersigned by a heavy hand.

Now what?

The domination of Hartford has become ever more irksome as the hand of the president weakened. Mr. Maxim was aware of the danger of figurehead presidency, even though he had apparently been kept from knowing how his prestige was being capitalized. The displeasures and the indignations of amateur radio all center around two words, *Hartford* and *Warner*.

The board can insure a bitter era of ill will by electing a new president marked with one of those words, and by keeping the offices at Hartford.

There is no reason for choosing a president by geography. There is no excuse for choosing him semi-secretly. The board now has a good chance to disavow the Hartford policy of secrecy, to use every legitimate method of securing the utmost in *public interest* in the choice of a new president who is not so located that he can be thought of as a "Hartford man," whose acts are not those of a "Warner man." If the board fails of this the new president will be distrusted as the present secretary is distrusted. The mark of Hartford will be on him.

Hartford itself should now be abandoned. There is no further reason for keeping the league there—none but the convenience of a secretary-general manager-editor to whom the League has already paid amounts running into six figures.

It might be best to leave that secretary at Hartford. He has established social and financial relations there; he owns a pretty "doggy" house. He claims to like the town of Hartford. Let us leave him there, but move the A.R.R.L. away.

The Board might well pick a "middle west" location—one, say, somewhere in Missouri between the center of population (southern Indiana) and the geographical center (western Kansas); the League's employees might welcome a cheaper place than Hartford in which to live.

"\$10,000 a year Warner," stranded at Hartford, could probably get along. The A.R.R.L. has paid him sufficient dollars in one way or another to raise him far above sympathy with mere radio amateurs. Also he is rumored to have told the board he can get "\$10,000 a year" elsewhere whenever he wants to.

Let's make him a gift of Hartford when the League moves along.



"Buttinsky"?

Though most amateurs would rather see 100 pages of technical and construction articles rather than 100 pages of radio policies in RADIO, they are interested in the welfare of amateur radio enough to want to see a certain amount of politics in the magazine. Some of our readers do not take *QST*, and look to RADIO to see what is going on in the League.

However, occasionally we find someone whose attitude is that we are "pretty small" to poke our noses into League affairs, especially since the League has its own "official organ". But the League affairs do not concern just the "members of *QST*", they vitally concern every amateur who is genuinely interested in the welfare of his hobby.

The Townsend League has its own "official organ", the *Townsend Weekly*. Even so, one can hardly find a single metropolitan newspaper in this country which makes no reference to the affairs of that organization. And so on with a hundred other organizations that have their own "official" publications.

No, we do not feel bound in any way by the ethics of the game to "lay off" mention of League affairs. Such is the world of politics. And so long as a good portion of our readers want it, we will continue to publish news and comment on League matters.

A Controlled Carrier, Grid Modulated Phone

By FRANK C. JONES

Grid bias modulation is an economical method of obtaining good phone operation, since very little modulation equipment is needed. In the past, one of its drawbacks was in the relatively low plate efficiency obtained, running from 30 to 40%. Plate modulation with its efficiencies of from 50 to 70% meant that the class C r.f. stage wasted less power within the

tubes. Grid modulation required larger tubes and higher plate voltages for the same carrier signal output; so the saving in modulator equipment was more or less cancelled.

In grid bias modulation, the modulated tube may run at about 40% efficiency with no modulation, wasting 60% in the tube plate circuit. At 100% modulation, the loss would run only 40%, since the efficiency changes and the side band power radiated would use up the 20% difference. The carrier would remain the same, accounting for 40% of the total input power. This means that the tube cools off during modulation. With plate modulation the opposite is true; the r.f. tube plate shows more heating effects during modulation.

By using controlled carrier with grid bias modulation, the tubes run cool during idle periods and heat up during modulation. Only during the peaks of modulation is the full plate input drawn by the modulated tube. In other words, we have a scheme for releasing additional plate input as a function of the audio input. In this system both the r.f. and a.f. grid excitation are varied in accordance with the voice input.

The full input occurs only at the time of 100% modulation, at which time the modulated stage is operating at about 60% efficiency as regards plate heating. The tube loss at this time runs at about 40%, the sidebands 20%, and the carrier at 40% of the total plate input. With no modulation the carrier efficiency may be 20% or even less, but since the total plate input is a fraction of that at 100% modulation, the plate heating is reduced greatly. The equivalent carrier output (maximum obtained during peaks of modulation) will then be the same as the plate dissipation, because these

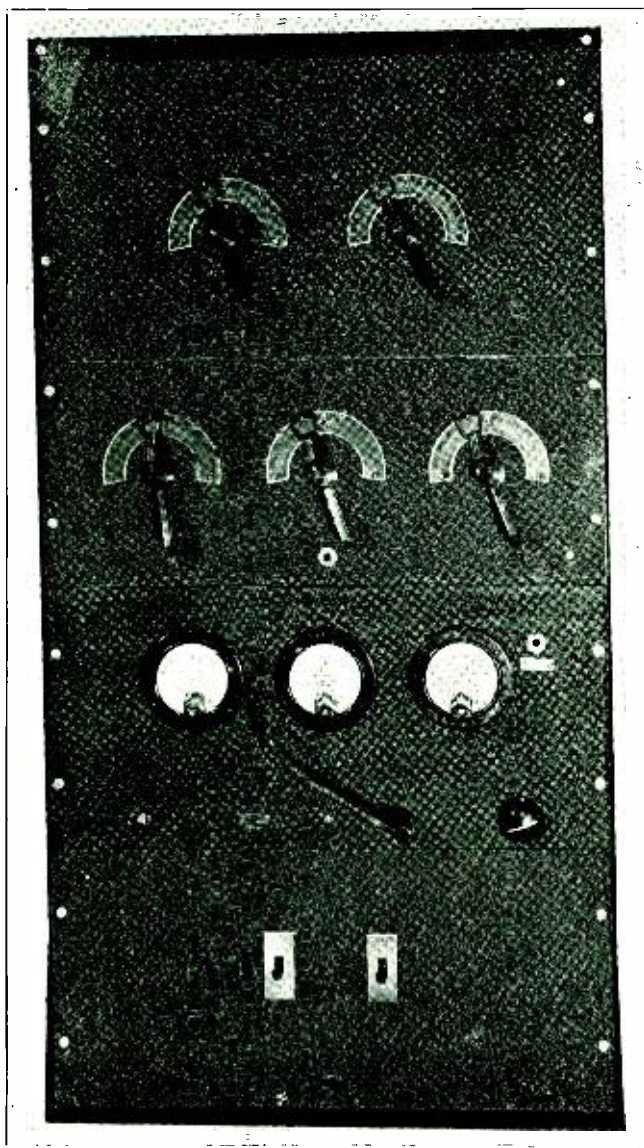

both run at 40%. This provides an easy method of calculating the carrier output obtainable with any tubes, as the maximum allowable plate dissipation is always listed. Typical examples would be 15 watts for a 10, 75 watts from a 50T, 100 watts from a 211, and 150 watts from an HK354, HF200, or 150T tube.

In the transmitter illustrated, a pair of 50T's provide between 100 and 150 watts of "effective" carrier output without reaching the input ratings for these tubes. A higher plate supply voltage than the one shown would allow greater outputs.

Carrier control is obtained by means of a 46 high μ tube acting as a voice-operated variable bias resistor in the r.f. buffer stage. The 46 tube acts as a cathode resistor, dropping its resistance when voice input is applied. Only the d.c. component acts on the buffer stage, as the voice audio frequencies are filtered out by means of a low pass filter consisting of two $\frac{1}{2}$ μ fd. condensers and a 30 henry choke. The d.c. current follows the voice envelope like any vacuum tube voltmeter or class B amplifier. The r.f. output of the buffer stage then varies in accordance with syllabic modulation as in any controlled carrier system. This furnishes a variable r.f. grid excitation to the grid bias modulated 50T stage. The latter operates with fixed grid bias equal to cut-off, plus an automatic cathode resistor bias set to between 60 and 100% of cut-off bias at times of peak modulation. The fixed grid bias is obtained from the low voltage power supply by operating the grids at ground potential and the 50T filaments and minus high voltage at + 130 with respect to ground. An 8 μ fd. condenser across this bleeder resistor section and another 8 across the 50T cathode resistor R_{18} by-pass the audio frequencies.

In this system of modulation, the buffer stage must be large enough to drive the final stage properly for c.w. operation. When controlled carrier phone operation is desired, the 46 tube is cut into the circuit, dropping the buffer stage input to about $\frac{1}{3}$ or $\frac{1}{2}$ even

on voice peaks. The r.f. excitation to the final stage is then only great enough to supply 5 or 10 milliamperes of d.c. grid current on peaks. A small Mazda lamp can be used to reduce the r.f. excitation to a low enough value to obtain good voice quality as checked on an oscilloscope or with a phone monitor.

A type 30-B tube was chosen in this set as 10 meter operation was desired, which meant doubling in this buffer stage. An 801 doubler at 600 volts did not supply enough output for either c.w. or controlled carrier phone on 10

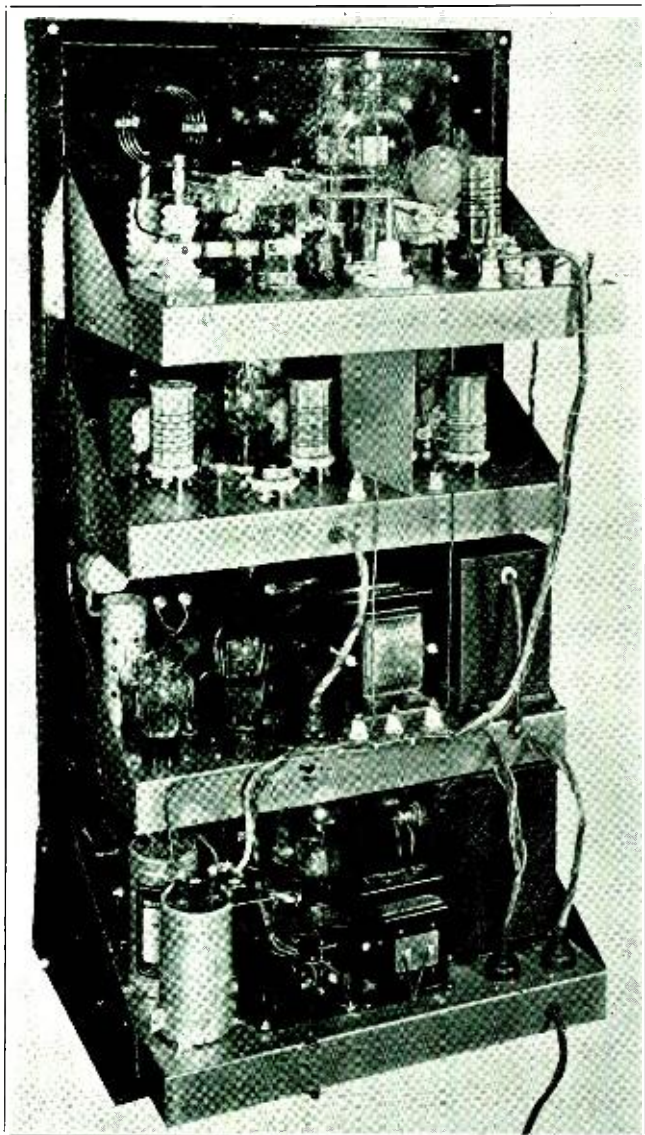



COIL DATA

Wavelength Meters	L ₁ Oscillator	L ₂ Doubler	L ₃ Buffer	L ₄ Final Grid	L ₅ Final Plate
160	56 t. no. 24 d.s.c. close-wound 1½" d.				
80	29 t. no. 20 d.s.c. 1½" l. 1½" d.	29 t. no. 20 d.s.c. 1½" l. 1½" d.	32 t. no. 20 d.s.c. c.t. 1⅜" l. 1½" d. 1 t. link	34 t. no. 20 d.s.c. c.t. 1½" l. 1½" d. 2 t. link to lamp	44 t. no. 16 steel cored wire c.t. 2⅛" d. 3½" l.
40	16 t. no. 20 d.s.c. 1½" l. 1½" d.	16 t. no. 20 d.s.c. 1½" l. 1½" d.	20 t. no. 20 d.s.c. c.t. 1½" l. 1½" d. 1 t. link	20 t. no. 20 d.s.c. c.t. 1½" l. 1½" d.	22 t. no. 12 2⅛" d. 3" l.
20	7 t. no. 20 d.s.c. 1½" l. 1½" d.	7 t. no. 20 d.s.c. 1½" l. 1½" d.	11 t. no. 20 d.s.c. c.t. 1½" l. 1½" d. 1 t. link	10 t. no. 20 d.s.c. c.t. 1½" l. 1½" d. 1 t. link to lamp	7 t. no. 10 c.t. 3⅝" d. 2" l.
10			5¼ t. no. 18 c.t. 1¼" l. 1½" d. 1 t. link	5¼ t. no. 18e. c.t. 1¼" l. 1½" d. 1 t. link to lamp	4 t. no. 10 2⅝" d. 2" l. c.t.

meters. The 30-B tube can be run safely to at least 50% greater plate current, which, together with a much higher mutual conductance, means greater output at low values of grid drive.

A 53 tube supplies enough output on either the fundamental or second harmonic to drive the 30-B to between normal class C and class B operation. The 53 tube has a plate resistor for reducing the 600 volt supply down to approximately 400 volts. This resistor plus a pair of 8 µfd. condensers in series provide additional power supply filter for the 53 tube. When possible, on all bands except 160 meters the 30-B tube is driven from the 53 doubler section, giving additional isolation to the crystal oscillator section.

The r.f. portion of this transmitter is straightforward in design and operation. Link coupling to tuned antenna circuit or to a twisted pair feeder antenna is used in order to obtain a good load balance on the final stage. The output on 10 meters runs well over 100 watts on phone and between 200 and 300 watts on c.w. Tests on this band gave louder reports when using controlled carrier than without it. The oscilloscope pictures showed less over-modulation effects and better quality than in other controlled carrier systems tested here. With steady tone input, the oscillograph pictures were identical to those obtained without controlled carrier except in amplitude.

The speech amplifier has a 2A6 high µ stage into a 56 stage, resistance coupled, driving a

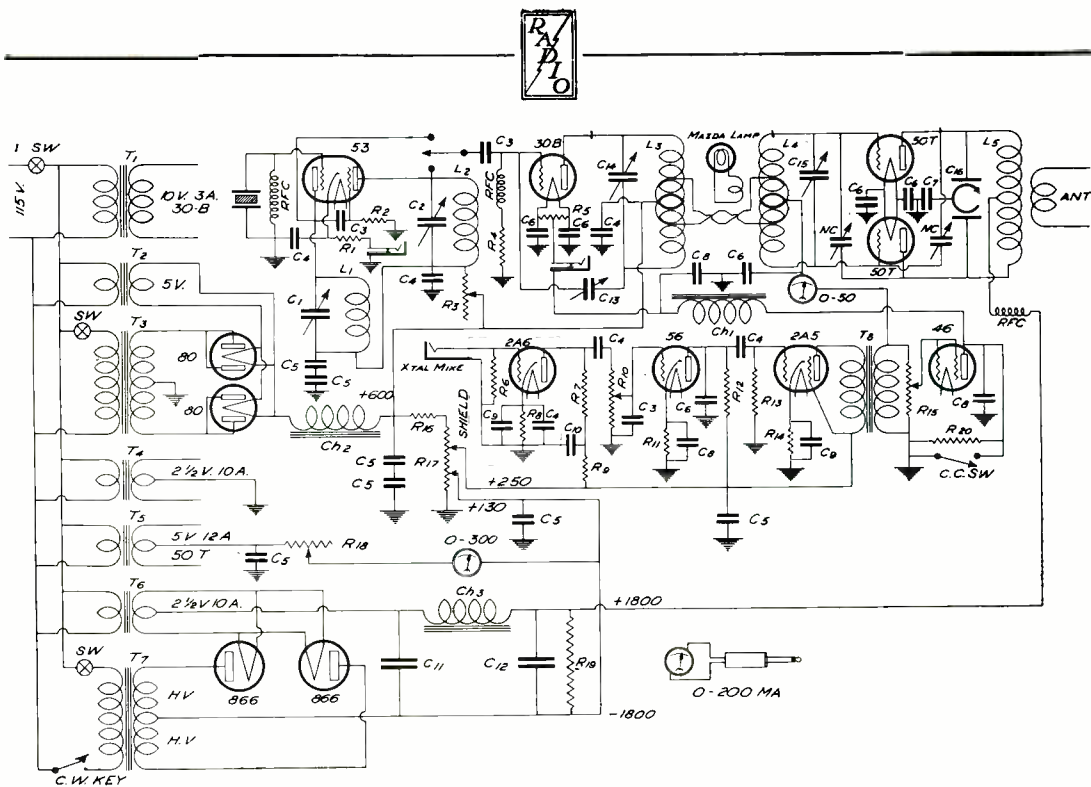

Wiring Diagram of the Controlled Carrier Transmitter

- C₁—100 μfd. midget
- C₂—50 μfd. midget
- C₃—100 μfd. mica, 1000 v.
- C₄—.01 μfd. mica, 1000 v.
- C₅—8 μfd., 450 v. electrolytic
- C₆—.001 μfd. mica, 1000 v.
- C₇—.002 μfd., 5000 v. mica
- C₈—.5 μfd. paper, 600 v.
- C₉—10 μfd. electrolytic, 25 v.
- C₁₀—0.1 μfd. paper, 600 v.
- C₁₁—2 μfd. 3000 v.
- C₁₂—2 μfd. 2000 v.
- C₁₃—35 μfd. double

- spaced midget
- C₁₄—50 μfd. double spaced midget
- C₁₅—70 μfd. double spaced midget
- C₁₆—80 μfd. per section 3500 volt spacing
- R₁—400 ohms, 10 watts
- R₂—50,000 ohms, 2 watts
- R₃—5000 ohms, 40 watts, with slider
- R₄—10,000 ohms, 10 watts
- R₅—100 ohms, c.t.
- R₆—3 megohms, 1/2 watt
- R₇—250,000 ohms, 1 watt

- R₈—5000 ohms, 1 watt
- R₉—100,000 ohms, 1 watt
- R₁₀—1 megohm pot.
- R₁₁—2000 ohms, 1 watt
- R₁₂—100,000 ohms, 1 watt
- R₁₃—1 megohm, 1 watt
- R₁₄—400 ohms, 2 watts
- R₁₅—10,000 ohms, 10 watts with slider
- R₁₆—5,000 ohms, 40 watts
- R₁₇—20,000 ohms, 40 watts tapped
- R₁₈—1000 ohms, 75 watts, with sliders
- R₁₉—75,000 ohms, 100

- watts, with sliders
- CH₁—20 by., 100 ma.
- CH₂—13 by., 250 ma.
- CH₃—20 by., 150 ma.
- T₁—10 v., 7 amp.
- T₂, T₃—5 v. at 4 amp. and 2 1/2 v. at 10 amp.
- T₄—1450 v. c.t., at 250 ma.
- T₅—2 1/2 v., 10 amp.
- T₆—5 v., 20 amp.
- T₇—3000 v., c.t., (1500 r.m.s. each side) at 250 ma.
- T₈—Grid modulation transformer

2A5 modulator tube. The latter has enough output to modulate the grid circuit of the 50T stage and also to drive the control carrier 46 tube. The latter has its grid tapped half way down on the modulator load resistor in order to prevent overload of the 2A5 tube. The 46 tube draws grid current and requires grid driving power, but to offset these two disadvantages it requires no fixed bias. A 2A3 tube biased to near cut-off would serve much more satisfactorily than the 46 tube if the inconvenience of an additional fixed grid bias supply could be tolerated.

Two power supplies furnish all voltages necessary and thus simplify construction and minimize space requirements. The high voltage supply has a 3000 volt center tapped power transformer, and in order to get as high voltage as possible without using a bridge rectifier, condenser filter input was used. This provides

about 1800 volts, and by bleeding it heavily, the voltage regulation is satisfactory for controlled carrier of moderate power swing. The resistor R₂₀ across the 46 tube output limits the degree of carrier control so that the final plate current varies from about 40 or 50 ma. up to about 140 when modulating. Swinging choke input to the filter would greatly improve the voltage regulation and allow more complete control of carrier output, but would require a transformer with about 40% more voltage output.

If plate voltages of 2500 or 3000 volts were to be used, the plate current would be lower and the output somewhat higher, especially on c.w. A plate tuning condenser with much greater plate spacing would be necessary to prevent r.f. flash-over. A high voltage mica bypass condenser connected between rotor and chassis ground on this tuning condenser will



prevent r.f. choke collapse in case of an r.f. arc across the tuning condenser plates. The d.c. short circuit accompanying r.f. arcs in many sets causes a collapse of the r.f. choke.

Push-pull connection of the 50T's was decided upon in order to insure satisfactory 10 meter operation. The plate leads cross over to opposite stator sections of the tuning condenser. This allows an easy method of neutralizing condenser construction. Aluminum plates about $\frac{1}{2}$ or $\frac{3}{4}$ inch apart, overlapping an area 2" x 2" will serve as neutralizing condensers. The fixed plate was mounted directly on the stator plate connecting screws, and the rotor plate was mounted on a Johnson coil jack and stand-off insulator in each condenser. Very short neutralizing leads resulted in perfect neutralization on 10 meters where difficulty is sometimes experienced. On 20, 40 and 80 meters, the c.w. output runs over 300 watts and the controlled carrier output was estimated at nearly 150 watts using lamp banks as a dummy antenna.

As in any grid bias modulated set, the antenna loading must be quite heavy, much more so than for c.w. operation. A good test for antenna load is to get the set into satisfactory operation without controlled carrier. The controlled carrier may then be used by cutting in the 46 tube and increasing the r.f. grid excitation. Quality should be checked with either an oscilloscope or phone monitor, and side band splatter checked with a selective single signal receiver. Operation should be maintained without overmodulation and splatter into adjacent channels.

The set shown was built into a three foot relay rack with the top panel being about 10 $\frac{1}{2}$ inches by 19 inches. The other panels should be 8 $\frac{3}{4}$ " x 19" and one 7" x 19" for the speech and low voltage supply if the rack space doesn't allow for three 8 $\frac{3}{4}$ " panels. The top and bottom chassis sizes are 12" x 17" x 1 $\frac{3}{4}$ ". The two center chassis are 9" x 17" x 1 $\frac{3}{4}$ ". The parts are mounted on the chassis using the parts as templates for mounting holes. All tuning condensers have insulated extension shafts to prevent grounding to the metal panels. The condensers are mounted on insulated strips. An extra 0-200 milliammeter, connected to a telephone plug, reads current through either the 53 or 30-B tube. Complete shielding around the crystal mike cord, plug, jack, and first tube prevent a.c. hum or r.f. pick up.

Controlled carrier with grid bias modulation

allows 50% more output to be obtained, or the same output as with normal grid bias modulation at greatly reduced tube heating. It approaches an ideal scheme for economical phone operation.

Television Prospects

Proceeding on schedule, the first field tests of television by R.C.A. will begin soon.

It is emphasized that this experimental test does not mean a regular television service is at hand. This represents an essential pioneering stage to estimate and define its possibilities under actual working conditions. For the first time it is disclosed officially that the television transmitter will be on the Empire State Building, in New York City. Further details of progress toward working out the plans for the test are revealed in the following paragraphs from the R.C.A. report:

"The New York area has been selected as the one in which the experimental field tests will be conducted. The television transmitter is located on the Empire State Building, and test receivers will be operated by technical personnel of the R.C.A. organization throughout this area. The transmitter will be connected by radio with the television studio, now under construction in the N.B.C. plant, R.C.A. Building, in Radio City, New York. The installation is practically complete, and within a month or two the first tests should commence.

"This does not mean that regular television service is at hand. It will be necessary to coordinate a number of important elements before television on a regular basis of service can be established. For example, it will have to be determined how far the transmitter can send good television pictures; also with what consistency and regularity pictures may be transmitted with the system in its present state of development. We must investigate and define the possibilities of the television camera for indoor and outdoor pick-up.

"These are the essential pioneering stages in the development of an art in which considerable expenditures must be made for research before returns can be expected. As the work goes on, it may be necessary to return to the laboratory, from time to time, to seek the solution to practical problems encountered in the field. But the R.C.A. experimental television project is proceeding on schedule, and your management is confident that it will continue to progress at an encouraging rate.

"It is, however, evident that, regardless of the progress in this direction, the present system of sound broadcasting remains the fundamental service of radio communication to the home. While television promises to supplement the present service of broadcasting by adding sight to sound, it will not supplant nor diminish the importance and usefulness of broadcasting by sound."

We are informed that one First District ham made it a point to serve "73" brand whiskey at a recent shackfest!

KDKA Boulevard is a street in a Pennsylvania town.



Diathermy Construction

By FAUST GONSETT, W6VR

In order not to bring the sky down upon our heads for showing a construction article on "one of them QRM machines," we will start off with a few pertinent facts on these "new fangled contraptions" as we heard one country doctor refer to his short-wave dia-

Many amateurs are picking up a good piece of "side money" by constructing diathermy machines to order for doctors in their locality. There is nothing particularly difficult about building one, and there is a substantial profit involved at the present prices these machines bring. Any amateur who has built his own transmitter and made it work can, by following this article, build a machine as good as those turned out by the diathermy manufacturers.

thermy he is being a "traitor to amateur radio" by building one of them.

A large number of the manufactured machines

use raw a.c. on the plates of the oscillator tubes. The use of a rectifier system adds but little to the cost, and cuts down interference considerably, in addition to having other advantages as will be explained later. By building the machine himself, the amateur can make sure that the machine uses rectified a.c., and that it will cause a minimum of interference.

If an amateur constructs a machine to order, he can supervise the installation, putting in line filters when necessary. If the doctor orders a machine by mail, it may arrive with a suggestion on the instruction sheet that line filters be employed, and that "chicken wire" underneath the plaster on the walls be grounded; but the doctor will very likely ignore the suggestions unless there is a city ordinance compelling him to take precautions against excessive radiation from the machine.

When a person is given a diathermy treatment, it is simply a matter of subjecting part of his anatomy to an intense, high frequency field, so that the tissues are heated by the flow of high frequency current. The diathermy would be no more effective than a hot water bottle, except that it permits the temperature of the inner tissues to be raised without the necessity for raising the temperature of the skin to an uncomfortable degree.

The instrument necessary for generating this high frequency current can be built by any amateur of average intelligence, or even less, out of parts commonly used in the construction of amateur transmitting equipment, and in but a few hours' time.

The machine is essentially a short-wave, self-

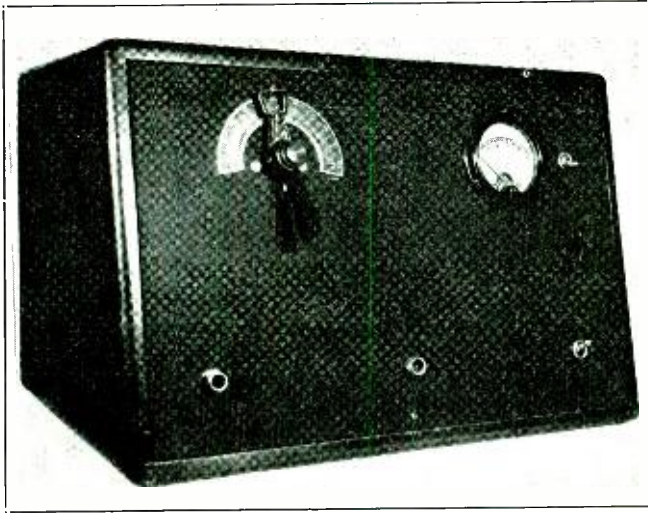

The 200 Watt, 16 Meter Diathermy Machine

thermy. The use of short-wave diathermy in the field of physio-therapy has swept the country by storm these last few years, and thousands of these machines have been sold at fancy prices, both to quacks and legitimate doctors and chiropractors.

The machines are not a fad, as they have definite therapeutic value; and there is still quite a market for them in spite of the large number that have been sold.

Doctors are going to buy these machines regardless of whether it is from the amateur around the corner who has a "sending set" or from a regular manufacturer. Therefore an amateur need not feel that just because diathermy machines are responsible for a considerable amount of interference on the short

200 Watt Short Wave Diathermy

C_1 —0.0001 μ fd. 5000 volt mica

C_2 —100 μ fd., 3000 volt spacing

RFC—Pie wound r.f. choke, 100 ma.

R_1 —25,000 ohms, 25 watts

R_2 —10,000 ohms, 25 watts

MA—0-250 m.a. d.c.

T_1 —10 v. 6.5 amps. and 2½ v. 10 amps. (2½ v. winding should have at least 3500 v. insulation)

T_2 —1400 volts r.m.s. each side center, 250 m.a.

L_1 —14 turns no. 10 enameled, 2½" diameter, spaced slightly more than diameter of wire, tapped at center turn and 4th turn each side of center.

L_2 —5 turns no. 10 enameled, 1½" diameter, mounted inside the tank coil. Turns spaced ¼".

Heating Pads — (Special Information on request.)

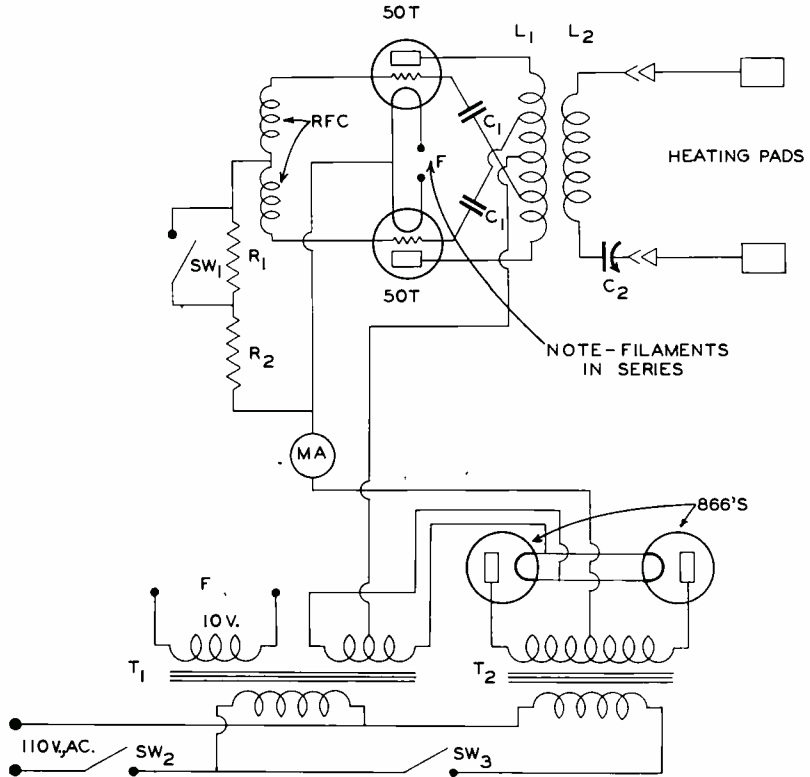

excited oscillator working on (usually) about 16 meters. Remember the old antenna-counterpoise radiating system, inductively coupled to our transmitter with a coil of several turns, and resonated with an antenna series condenser? Well, just substitute for the antenna and counterpoise a couple of rubber-insulated pads with connecting cords of the right length, and you have a diathermy machine. Yes, it is as simple as that. No hokus-pocus about the thing; it is just a self-excited transmitter and not a very fancy one at that. In fact you would have to build a much better one if you wanted to put it on the air without getting a pink ticket from a monitoring station.

An available output of around 200 watts is required, and therefore these machines generally use either a pair of 50T's or high-frequency "50 watters" of special type 211 or 203A design. Push-pull is generally used for the same reason that push-pull is desirable in a high frequency transmitter in which two tubes must work together to furnish sufficient output.

The type of oscillator circuit used is of little importance, though the most commonly used type seems to be the Armstrong circuit, with an

untuned plate tank and a tuned grid coil. However, a push-pull Hartley was chosen in preference to the t.n.t. circuit because the grid-plate capacity of the 50T's is so low as to make tuning adjustment critical when used in the Armstrong circuit. The tubes were first hooked up in a tuned-grid untuned-plate circuit, and slight movement of the heating pads caused the plate current to jump as much as 100 per cent. Also, the circuit had a tendency to go out of oscillation at times under certain conditions of load unless the grid tuning were readjusted. These effects are explained by the fact that varying the resonant frequency of the plate tank of an Armstrong oscillator also affects the excitation to a major extent. Because no lump capacity is used across the plate tank (other than the circuit capacity) the tuning of the pickup circuit, due to the close coupling required, affects the resonant frequency of the plate tank, which in turn affects the excitation.

When the circuit was changed over to a Hartley, the plate current varied much less when the pads were moved or handled, and the circuit showed no tendency to go out of oscillation regardless of loading. If tubes with

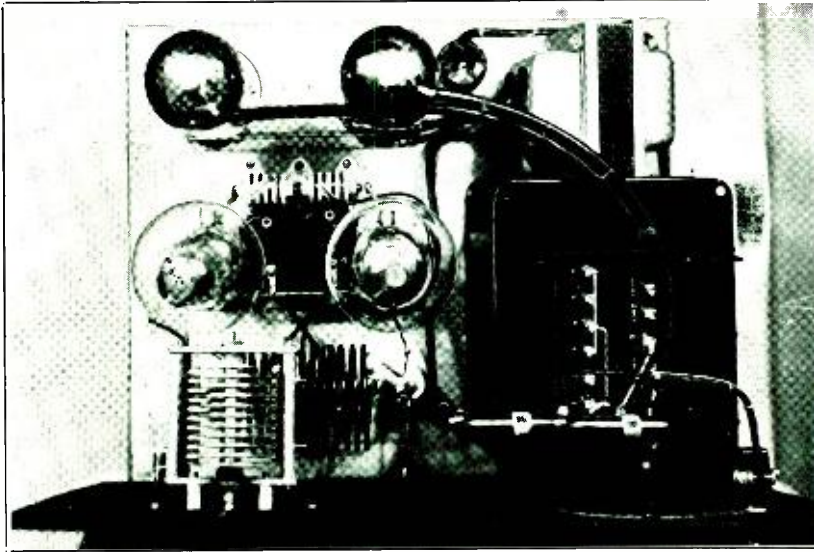

Top View with Baseboard Slid out of Cabinet

higher grid-plate capacity had been used, the advantages of the Hartley over the Armstrong would be less apparent, but would still hold to an extent.

The heating pads are nothing but two rubber-covered electrodes about 8 inches square, with connecting cords of such length that the cords and pads resonate at approximately 16 meters when applied as in normal use. Changing the spacing of the pads or the dielectric (patient's body) will change the resonant frequency of the pads, and resonance is restored by the series condenser C_2 . This condenser is also used for fine adjustment of the output, coarser adjustment being accomplished by the "low-high" switch.

The use of rectified full-wave current not only reduces interference to radio reception, but is easier on the tubes, adding several hundred hours to their life. Also, more heating effect is produced for a given peak power output than when raw a.c. is applied directly to the plates of the oscillator tubes. This is advantageous from several standpoints. Also, when raw a.c. is used, the current is always flowing through the secondary of the plate transformer in the same direction, making a larger transformer necessary for a given wattage due to the tendency toward saturation of the core.

Note that the filaments of the 50T's are in series. This makes a centertap resistor and centertap condenser unnecessary. Also, we were unable to find a transformer commercially avail-

able with a 5 volt 12 amp. winding and a $2\frac{1}{2}$ volt 10 amp. winding on the same core, and two separate transformers would take up more room.

The cabinet may either be made at your local mill, or may be one salvaged from an old-time radio receiver of 1920-1928 vintage. You can usually buy these for a song, and if you can find one the right size you can afford to throw all the rest of the receiver away and still be

money ahead. The important thing to remember in using such a cabinet is to provide a sufficient amount of ventilation.

The front panel was cut from "tempered" Masonite, and given a coat of black crackle paint. It was feared that the conductivity of this paint would make necessary the insulation of the pad jacks and tuning condenser from the panel, but such was not found to be the case. However, the jacks should not be mounted closer than about 4 inches to any metal on the panel, or to each other.

The "low-high" switch is across a 25,000 ohm resistor that is in series with the regular 10,000 ohm grid leak. Thus on "high" we have 10,000 ohms, and on "low" 35,000 ohms. Further adjustment is secured by adjustment of the condenser C_2 .

The power transformer delivers 1400 volts, r.m.s. (full wave). At this voltage, the tubes should not be loaded to more than 250 ma. if the dissipation rating of 75 watts per tube is to be observed (switch on "high" position). Rather than using a higher scale meter with a red mark on it at 250 ma., a 250 ma. meter was chosen. Doctors have a habit of ignoring occasionally or not noticing the little red mark, but are much more inclined to take note and show concern when the meter goes off scale. Usually, maximum power will not be required, and the meter will ordinarily read between 150 and 200 ma. with the 1400 volt supply.

The scale on the tuning condenser does not

mean anything; the output is gauged by the rise in plate current above the normal unloaded value. The dial and scale were put on merely for appearance; a small, plain knob with no scale would have done just as well. Some manufacturers have as high as 3 or 4 meters on the panel, just for effect, as they say they can ask (and get) \$25 to \$40 more for the machine. The meters seem to make an impression on the patients, and the doctors are quick to appreciate this.

One doctor told us that he was forced to add a dummy meter to the lone plate meter on his machine, because several patients remarked that Dr. So-and-So had a much better machine (meaning two meters) and didn't charge any more for treatments!

However, any meters other than the plate milliammeter are somewhat of an unnecessary refinement, and our conscience wouldn't permit us to incorporate them. A grid milliammeter is handy when making initial adjustments, but of no necessity after the excitation has once been permanently adjusted. The doctor wouldn't know how to interpret a too-low or too-high grid current reading anyhow. But if you must have more meters on the panel to pacify your customer, we suggest an r.f. ammeter in series with one pad, and a 0-75 m.a. d.c. grid meter in series with the grid leak. This size of grid meter is correct for 50T's; if other type tubes are used, a different scale might be required. By putting our tongue in our cheek we can justify the presence of the r.f. ammeter by calling it a "resonance indicator". It is an unnecessary refinement, nevertheless, because maximum output coincides very closely with the plate current peak when the tuning condenser is varied. And the reading of the r.f. meter is *not* a relative indication of the heating effect, because the reading depends not only on oscillator output but on the position of the pads on a person's body. The plate current rise serves just as well as a "heating strength" or "power" indicator.

The coils are wound of no. 10 enamelled wire, and are self-supporting. The output coupling coil is mounted inside the tank coil, the tank coil being supported both at the ends and

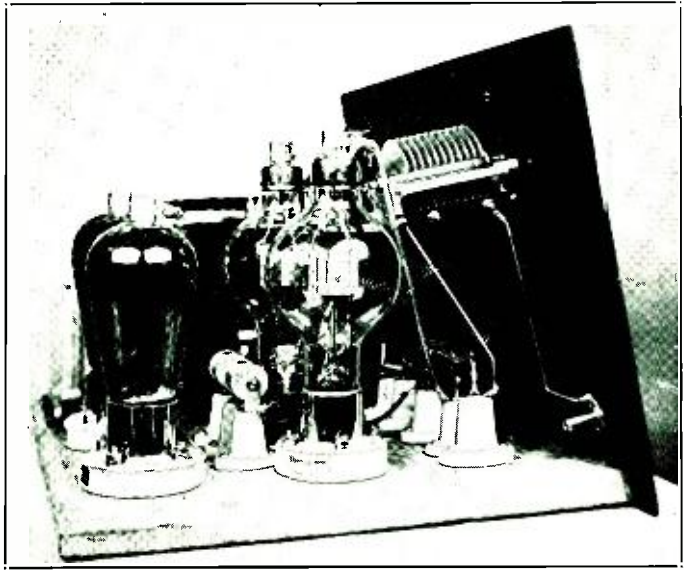

Side View. Note the Sloping Panel.

the center. Be sure that the grid wires cross over. The push-pull Hartley is a very stubborn animal, and refuses to work properly (if at all) when the wires are not crossed.

When choosing sockets for the tubes, make sure that they make good firm contact, as they must carry 5 or 6 amps. The high voltage connections are wired with high tension ignition cable. The rest of the construction is standard practice.

Be sure to impress upon the purchaser that he *must* refrain from putting his hands inside—especially when it is on—and also not tamper with the machine under any circumstances. A safety precaution not shown in the diagram is a .001 or .002 μ fd. 5000 volt mica condenser in series with the side of the pickup coil that does not go through the tuning condenser. In this way, one does not have to rely on the rubber insulation of the pads to prevent possible electrocution or bad shock should one of the supporting standoff insulators crack from stresses and allow the pickup coil to touch the tank coil, the latter being "1400 volts r.m.s. plus to ground".

Another thing that should be impressed upon the purchaser is the importance of allowing the filaments to run a few seconds before throwing the switch that applies plate voltage. Non-observance of this is hard on both the 66's and 50T's.

And in conclusion, we would like to warn



you against any extensive attempts at self-treatment or treatment of friends unless you are familiar with this branch of physiotherapy, and know just what you are doing. Maybe the doctor you sell the finished instrument to doesn't know a grid leak drip pan from an electrolytic variable tuning condenser, but at least he knows what the machine will do, and how to use it.

If you don't sell the machine at a big enough profit to buy yourself a pair of HF-200's or HK-354's for that new rig you are planning, you evidently are not much of a horse trader. We know of one instance where an amateur constructed a machine and sold it at 100 per cent profit, and the doctor that purchased it was skeptical because he didn't see how it could be any good, seeing as how it cost but a little over half the price of a factory manufactured machine he had just had demonstrated to him a short time before.

Moral: Don't be bashful about asking a good price for the machine; the diathermy

manufacturers certainly are not, and they seem to have no trouble selling them.

◆ A New Kind of "Amateur Hour"

W8XWJ (WWJ, the *Detroit News*) has started a weekly amateur program and will appreciate any current or historical material that might be of use on a broadcast of this nature. The station transmits on 9.488 meters with 500 watts input. The antenna is the highest thing in Detroit, being 800 feet above the street.

Here is one amateur hour without a "gong", unless maybe they use one for time announcements.

◆ Radio, according to one of the declarations attributed to Edison, deserved the name of commercial failure. He claimed that no dealers were making any money out of radio and that its popularity was waning with the public. In 1903, he sold a wireless patent to the Marconi interests.

SIMILAR RECEIVING TUBE TYPES

2.5 VOLT CATHODE		6.3 VOLT CATHODE			2.0 VOLT CATHODE		COMMENTS
<i>old</i>	<i>new</i>	<i>old</i>	<i>new</i>	<i>metal</i>	<i>old</i>	<i>new</i>	
27	56	37	76-955	6C5	30	—	General purpose triode
24	57	36	77-6C6-954	6J7	32	840-1B4	Constant μ tetrode or pentode
35	58	39-44	78-6D6	6K7	34	1A4-1C4	Variable μ tetrode or pentode
—	2A6	—	75	6Q7	—	—	Diode-triode, high μ
—	55	—	85	6R7	—	1B5	Diode-triode, medium μ
—	2B7	—	6B7	—	—	—	Diode-pentode
47	2A5-59	38-89	41-42	6F6	33	1D4	Power pentode
45	2A3	—	6A3	6D5	31	—	Power triode
—	53	79	6A6	6N7	19	—	High μ twin triode (zero bias)
46	59	89	—	—	49	—	Zero bias triode, high μ
—	2A7	—	6A7	6A8	1A6	1C6	Pentagrid oscillator-detector
—	—	—	6F7	6P7	—	—	Triode-pentode

The tubes shown on each line above are all essentially similar but are not necessarily interchangeable merely by changing the cathode heating voltage. There are slight differences in electrical characteristics although the tubes on each line were designed to serve the same purpose. Incidentally, the tubes shown under the

"old" columns are not obsolete. In general, the newer types would be utilized by a designer of new equipment but occasionally one of the older types will be found to have some advantageous feature, for some particular circuit application, over the newer types. Also note that not all of the newer types are in quantity production by all of the major manufacturers.



Getting the Most from the Twisted Pair

By ROBERT C. GRAHAM*

The twisted-pair r.f. transmission line has rather recently been enjoying some long-sought-for prestige. It is the purpose of this article to explain the correct ways and means of improving twisted-pair performance.

To avoid complicating this paper with extensive tabulations, a low-impedance twisted pair will be assumed at the start. Such wire, designed for operating at amateur frequencies, is now available commercially. A few words pertaining to the design and construction of that material may be of interest. To begin with, why should 72 ohms have been picked as the desired impedance value? The major reason is that 72 ohms is the *average* radiation resistance of a half-wave doublet antenna. The radiation resistance is not completely constant, varying somewhat with height as shown by figure 1, but 72 ohms is an average, marked by the dashed line in the figure. At the center of the antenna 72 ohms is also the characteristic impedance; so by merely connecting our line to the center of such an antenna we arrive at a very sure method of impedance-matching. It so happens that a 72 ohm pair with solid insulation (paper and rubber) can be constructed to give fairly low losses whereas a pair of higher surge impedance would mean higher losses.

The first step in the design was the choosing of a proper conductor. For no reason except satisfactory past experience the old stand-by no. 12 solid copper was selected. Since tinning this wire as a protection against corrosion caused by the rubber covering would also raise the r.f. skin resistance, no tinning was used, a wrapping of thin paper being substituted. Rubber was selected as the insulation, a low-loss rubber compound being used which had shown remarkable moisture resistance in submarine telephone service. This material has a dielectric constant of 2.7. Knowing this and the wire-diameter it was possible to calculate the proper thickness of the rubber. Referring to figure 2, D_1 is the diameter of No. 12 wire, and as soon as we know the dielectric constant of the insulation (shown in black) the proper value of D_2 to give 72 ohms impedance can

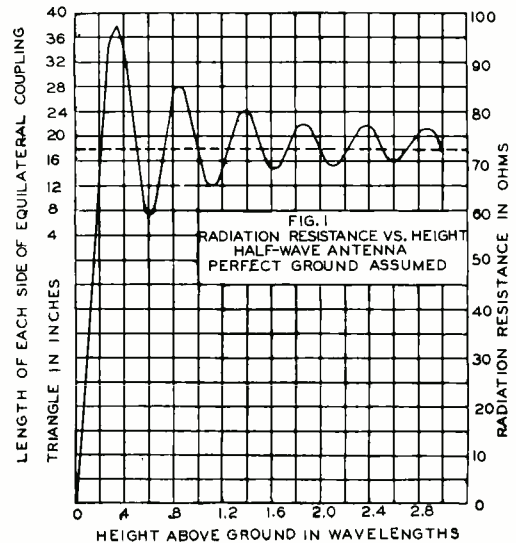

Figure 1

be calculated. This done it developed that the wires were to be spaced about 0.17 inch, center to center. The finished pair, however, is not long-lived if water and sunlight have free access to the rubber; hence an outer braid was provided with a pitch impregnation and mica finish. These details are given because they enter into the design of any serviceable twisted pair for outdoor use, no matter what impedance may be wanted. They explain why lampcord and the like are not especially successful in such service.

Probably the most desirable feature of such a low-impedance twisted pair is its utter simplicity and convenience, to the point of being foolproof. Being an untuned line, any length is permissible (within limits to be mentioned later). It may be strung up haphazardly with many turns and angles. The voltages are low and no supporting insulation is needed.

Another major advantage is in the reduction of radiation from, and pickup by, the line. Close spacing and transposition accomplish this. To clarify this argument let us compare a 600-ohm line (6 inch spacing) with a twisted pair as already described, which has a spacing we shall call 0.2 inch for convenience of calculation, though actually smaller. Assuming the current to be the same in the two lines the

*Engineer, General Cable Corp., Rome, N.Y.

radiated power is proportional to the line spacing *squared*, or a value of 36 for the 600 ohm line and a value of 0.04 for the 72 ohm line. Notice that this represents a decrease by a factor of 900!!

Perhaps the best proof of the extreme importance of the reduced pickup lies in the success of the familiar antinoise broadcast receiving antennas, which depend on precisely the same sort of an effect. Similarly, experience shows that sending antennas with low-impedance twisted-pair feeders do greatly reduce local interference, and are at present about the only simple solution for the crowded apartment-house location, or for duplex operation—if you must have that.

(EDITOR'S NOTE: There are additional reasons making a high-impedance line undesirable, especially for crowded locations. The higher voltages on such lines greatly increase the tendency toward visible or invisible corona ["brushing"] at the insulators, a tendency increased by the physical irregularity in the line represented by the insulator. Brushing is always a spasmodic phenomenon and in addition to being a power-loss is ideally suited for shocking nearby tuned circuits, almost regardless of their frequency. This is especially the case for tuned high-impedance lines, the commonest kind used by amateurs, which have unequal voltage along their length.)

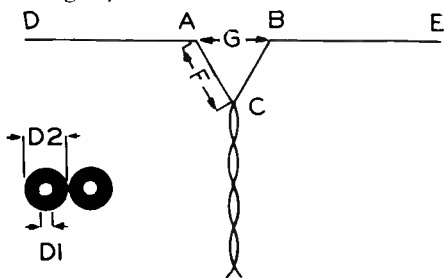

Figure 2

Figure 3

One of the evils of line-radiation is feedback to the transmitter. The more stages the transmitter has, the better the opportunity for this type of damage.

Experience has also shown that it is easier to "balance" a twisted-pair line (adjust for same current in both wires) than is the case for other feeders.

Line Efficiency

It is for such advantages as these that we can forgive the twisted-pair for some of its shortcomings, chief of which is the actual attenuation loss. With reasonable lengths these are fortu-

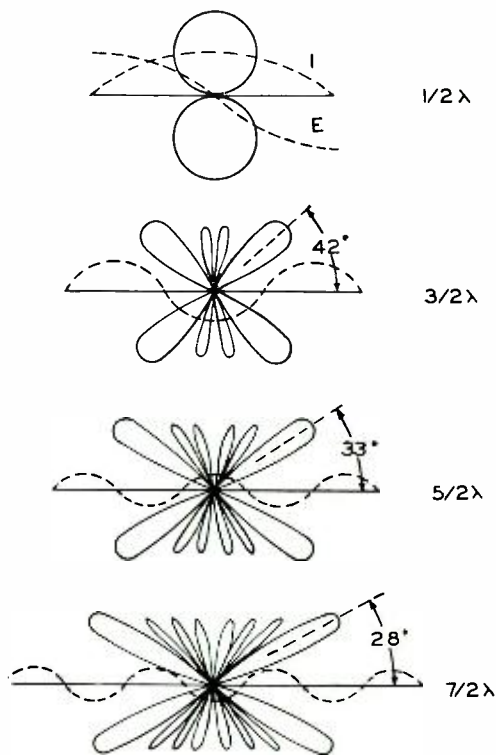

Figure 4

nately not excessive. Table I shows the losses to be expected with 72 ohm line-wire such as was first referred to. Such a table would be very complicated if all possible sorts of wire were to be included. Shorter feeders give a correspondingly lower loss.

TABLE I

Length of 72 ohm twisted-pair line (Type EO-1, with no. 12 wire, spaced 0.17" on centers) which produces 15% power loss.

Frequency	Wavelength (approx.)	Greatest permissible line length
1750 kc.	172 m.	650 feet
3500 "	85.5 "	325 "
7000 "	43 "	175 "
14,000 "	21.4 "	100 "
28,000 "	10.7 "	60 "
56,000 "	5.35 "	35 "

Coupling to the Transmitter

The coupling of the transmitter to the line should be correct if proper results are to be expected. Again picking a specific case for the sake of avoiding endless talk, we will consider how a 72 ohm twisted-pair line should be coupled to the transmitter. Since the line is of low impedance it operates at low voltage, and therefore at relatively large current, though by

no means at currents as large as are to be found at *some places* along tuned feeders such as the "zeppelin" and similar types. We accordingly choose to couple to a low-voltage portion of the final tank coil of the transmitter.

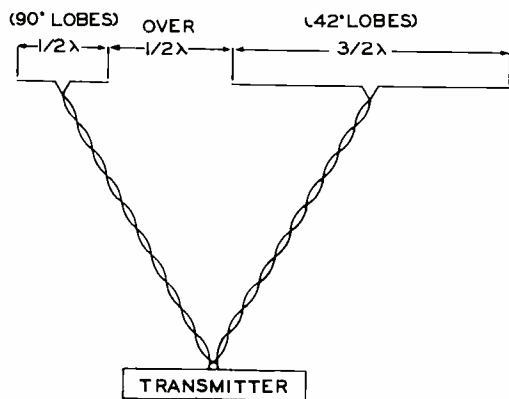

Figure 5

The *last*, and most troublesome, choice of coupling methods is to tie the line wires to the final tank coil through blocking condensers of 0.002 microfarads or thereabouts. This method is very critical in adjustment. It is not recommended, though permissible.

Another, and widely used, method is to connect the line to an *untuned* coil of 1 or 2 turns placed around the final tank coil, and varied in diameter or turns to produce the desired load on the output tubes. The untuned coil should surround the low-voltage part of the output-tank coil, which may easily be found with a lead-pencil or neon bulb, not using much power, and hunting for the part of the coil which produces the weakest indication.

Stand on a chair, keep hands, legs and head clear of wires, and live longer. When the line is properly adjusted it carries no high r.f. voltages, either between wires or to ground. If a transmitter is working with a fair amount of power, one very simple test is to grasp the line firmly with your hand. The meters should not move, nor should the line show any heating. One amateur, as an experiment, even wrapped several turns of the line around an unshielded microphone cord without bad effect; but that is not recommended. Another fairly good method is to adjust for the greatest grid current in the final stage while at the same time holding the stage to its proper plate current. This should give the greatest antenna current for that particular plate input.

The third, and best, choice for a coupling method is a pi-section tuned network. The complications of this method are partly excused by harmonic suppression.

Coupling to the Antenna

Coupling at the antenna should be fairly precise. In the following discussion the antennas are shown horizontally, though manifestly the halfwave types at least can be operated vertically if purely non-directional, low-angle transmission is desired.

The line should leave the antenna for some distance at right angles to the antenna wire, or at least at an angle of 45 degrees or more, to avoid standing waves along the line.

It has been said that a 72 ohm line matches the *average* impedance of a halfwave antenna, still assuming the antenna to be horizontal. However, as figure 1 shows only too clearly, we cannot simply let it go at 72 ohms, for the various heights of antennas may present us with the need of matching antennas with impedances all the way from 60 to 100 ohms. Figure 1, by the way, refers to "effective" height, but this is reasonably close to actual height over most soils. (Not in Connecticut's rocky hills.—R.S.K.) In some extreme locations tin roofs, trees, and houses reduce the effective height to a small fraction of the height above earth, but in a doubtful place one may first try $\frac{3}{4}$ of the actual height, applying that to the curve of the figure 1 to get the impedance at the center of the antenna.

The "Y Match"

The "Y match" method of figure 3 is a common and simple means of adjusting the line impedance to the antenna impedance. A length

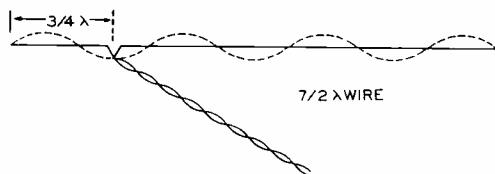

Figure 6

"G" of the antenna-wire is removed and the line is "forked" for some distance back, shown as "F" in figure 3. It is convenient to make F and G the same length. These lengths are shown on the left edge of figure 1, and these figures are the important ones—those at the right being of academic, rather than practical, interest.

Because the impedance of the line changes at the point C, and at the points A and B, there

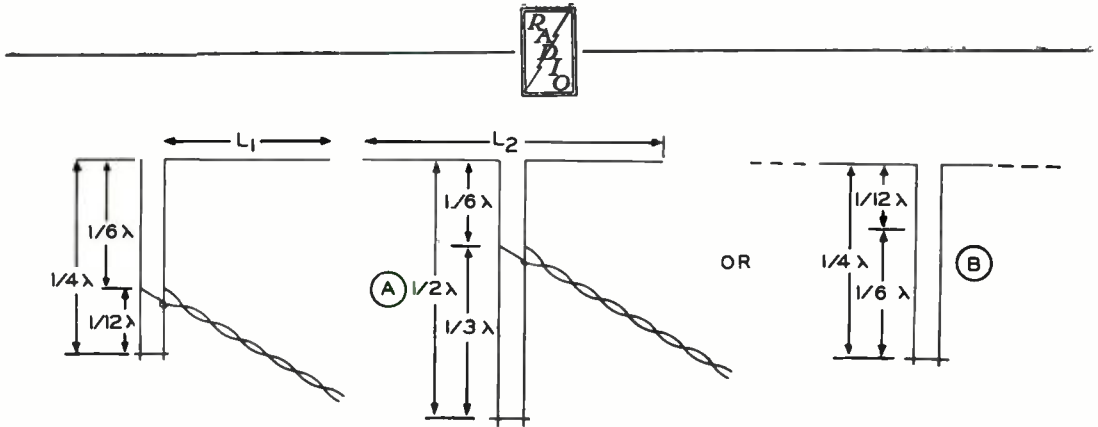

Figure 7

are small voltage "bumps" at these points. Those at A and B are relatively unimportant, and add nothing to the job of the insulators used to tie A and B together. The story is different at C, and it is accordingly important that moisture be kept out of the crotch, especially as it might work in along the paper-wrap of the wire. Plenty of rubber tape and the electrical repairman's old reliable friend "P & B insulating paint" will do the trick. If "P & B" is strange to you, ordinary automobile top dressing will do nicely—not the thin stuff like "Duco," but the more "goosey" kind.

Delta Match

It is mechanically simpler to leave the antenna wire uncut, and to bridge the split line across a portion of the uncut antenna. This "delta" method of matching is not as flexible as to frequency, and for that reason, perhaps, is in little use among amateurs for low impedance lines. It is quite practical, though the triangle dimensions are not those given by figure 1.

Harmonic Operation

If a horizontal antenna is made $3/2$, $5/2$ or $7/2$ wave long instead of $1/2$ wave, we increase the horizontal directive effect. The total radiation is not changed materially, but more of it goes in particular directions. This is shown by figure 4. In the top diagram of that figure we are supposed to be looking down on a $1/2$ wave horizontal antenna. The dashed line "E" shows the voltage along the antenna, the dashed line "I" shows the current, and the solid "figure 8" shows the directional effect. (Insofar as this antenna has any *practical* directional effect, it works well in every direction save endwise.—R.S.K.)

In the 2d diagram we look down on a $3/2$ wave antenna, the dashed line showing current distribution and the solid loops showing the pattern of transmission: four broad loops at 42 degrees to the antenna.

The $5/2$ wave antenna gives sharper loops at 33 degrees, while $7/2$ gives some nice beams at 28 degrees.

Several things are to be noted. As the antenna is made longer the major directional lobes become narrower and consequently longer—meaning stronger—but also there are growing up at the same time smaller lobes, intentionally shown in somewhat exaggerated size, which do produce signals in additional directions and may puzzle the operator of the antenna who does not expect transmission in those directions.

The impedance of these longer antennas, when "looked into" at their centers, is greater than that of a half-wave antenna, as shown by table II. With this in mind, a larger coupling triangle has been used by the author to operate successfully odd-half-wave antennas up to and including $7/2$ wavelengths.

The $7/2$ Wave Antenna

The $7/2$ wave system was very useful, in that 2-band operation was most practical. If the $7/2$ wave antenna is made for 14,000 kc., we find that it is a $1/2$ wave antenna for 2000 kc. Similarly a $7/2$ wave 10.7 meter (28,000 kc.) radiator is a $1/2$ wave antenna for 75 meter (4000 kc.) phone.

TABLE II

Impedance at the center of various horizontal antennas at great height. Practical antennas will vary 25% both ways from these figures.

Length of antenna	Impedance
$1/2$ wave	72 ohms
$3/2$ "	100 "
$5/2$ "	118 "
$7/2$ "	125 "

A $3/2$ wave section for 20 meters (99 feet), operating as shown in the second diagram of figure 4, is also a good actor. The four main lobes (alone) cover much territory. This 99 foot antenna should be no good whatever in the 40 and 80 meter bands, but is being so used at several amateur stations, with success. Pi-



coupling networks do the trick, but this type of operation is not recommended, and is merely passed along to those who absolutely must have 3-band operation from a doubler.

Good performance has recently been obtained at the writer's station at 20 meters with the arrangement shown in figure 5. This is an arrangement of two antennas with different directional patterns.

Off-Center Feeding

Where it is not physically possible to feed the center of the antenna, an arrangement such as that of figure 6 may be used. Since the (radiation) load is no longer the same for the two line wires their currents will not be quite equal, but the radiation pattern remains substantially unchanged. The line attaches at a current maximum point; that is, at an odd number of quarter-waves from the end.

Unequal line currents may also be found where one "half" of the antenna is not of the same length as the other "half". They may also be met where one end of the antenna is materially higher than the other, but in no case does any harm seem to result.

Lecher-Wire Impedance Matching

The Y method of matching need not necessarily be used. It is quite possible to use Lecher-wires as the impedance-matching device. In figure 7, at the left, is shown a $\frac{1}{4}$ wave section of this sort, used to "end feed" a $\frac{1}{2}$ wave radiating section. This is nothing more than the familiar "zeppelin" antenna with the 72 ohm line attached at such a point as to find a 72 ohm load. The length L_1 is $\frac{1}{2}$ wavelength (electrically).

Lecher-wire sections may also be used to feed at other points along the antenna. At A is shown a $\frac{1}{2}$ wave section center-feeding a $\frac{1}{2}$ wave antenna, L_2 being $\frac{1}{2}$ wavelength. At B is shown still another arrangement. The adjustments of such arrangements have been discussed in recent articles and need not be gone into here.

Other Antennas

From the foregoing the application of twisted pair lines to "V" antennas, vertical antennas, and other radiators may suggest itself to the reader. If "stretchless" antenna wire is used, and the suggestions are followed, it is felt that the twisted-pair line will accomplish more than the contribution of convenience. For those who desire further reading the following references are offered in the I.R.E. *Proceedings*:

"Development of Directive Transmitting Antennas," Carter, Hansel, & Linderblad, Oct. 1931.

"Circuit Relations in Radiating Systems," C. S. Carter, June 1932.

"Transmission Lines for Shortwave Radio Systems," Sterba and Feldman, July 1932.

HIGH-RESISTANCE VOLTMETERS

The use of inexpensive low-resistance voltmeters frequently leads to erroneous readings and much confusion among uninformed service men, experimenters, and amateurs.

The sensitivity of a voltmeter is expressed in "ohms per volt" and equals the total resistance of the meter divided by the number of volts indicated at full scale deflection. This figure indicates how much current it takes to operate the meter. For instance, if an 0-10 voltmeter has a resistance of 10,000 ohms, the sensitivity would be 1,000 ohms per volt, and from Ohm's Law it is easily ascertained that the meter requires a current of 1 ma. at full scale deflection. Similarly, if the 0-10 voltmeter had a resistance of but 1,000 ohms, the sensitivity would be 100 ohms per volt, and would require 10 ma. to move the needle to full scale deflection. This illustrates that: The higher the resistance of the voltmeter for a given range, the greater the sensitivity.

The lack of sufficient sensitivity results in inaccuracy when the instrument is used in high-resistance low-current circuits. Thus if a low-resistance low-sensitivity voltmeter is connected across a high-resistance value, the paralleled resistances alter the circuit to such degree that, although the voltmeter accurately reads the voltage impressed upon it at that moment, a false picture is obtained of the normal working condition of the circuit. It is obvious, then, that the resistance of the voltmeter must be such that it will not materially alter the conditions in the circuit to be measured. This is satisfied by an instrument of 1000 ohms per meter sensitivity, which, while more costly, will avoid troublesome errors.

—Aerovox Research Worker.

A highly fantastic prediction of the last decade depicted a lens which would enable radio men to look into sets and see r.f. currents scurrying about. During the same period, a magazine cover design showed radio in the year 1935—two fans looking into a television scene from the jungle, while overhead hung a chandelier burning cold light.



High Efficiency Frequency Doublers

By E. M. DOWLING

Few of the elements of a modern crystal-controlled transmitter are so little understood generally as the frequency-multiplying amplifier. For too long it has remained the most inefficient portion of a transmitter.

Anyone who has tried to get any power out of a frequency doubler knows how hard it is to

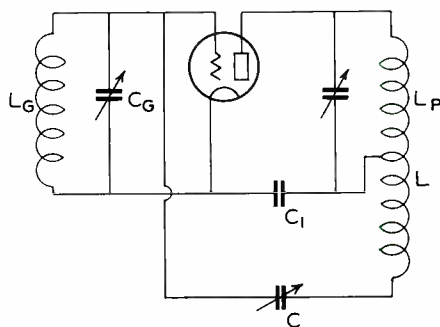

Figure 1

keep the tube from overheating, and how little output can be obtained as compared with the same size tube as a "straight amplifier." To feed the antenna from a doubler is so wasteful, of tube capability as well as power, that only where apparatus, space, or weight is at a premium, is it ever justifiable. Why, then, should such inefficiency be tolerated when a doubler is used to drive a following amplifier? When the latter uses the same size tube as the doubler, the whole thing could be dispensed with if the doubler tube could be made to do what it is capable of doing when used as an amplifier. Perhaps we may reason that the doubler is doing enough in doubling, without being expected to deliver the full power of which the tube is capable. That isn't necessarily so.

No doubt many amateurs have worked over a hot and seemingly balky doubler, thinking something amiss when actually everything was normal—as normal as it could be with the unfavorable conditions under which a doubler ordinarily operates. Those who realized this have doubtless wondered if the conditions couldn't be improved so as to at least partly

Theory, construction, and adjustment of a high-efficiency doubler, greatly simplifying transmitter construction and making possible two-stage 7, 14, and 28 mc. transmitters of high output. This article will enable you to get more output from your present doubler, even if it already employs regeneration of one form or another.

remove the cause of the inefficiency. This cause is simply that the tube is being driven to take power from

the plate supply, but no place is provided for most of this power to go. The grid is swinging the plate current at one frequency (the fundamental) and the load in the plate circuit is effective at another (the second harmonic). There is nothing to suppress the fundamental-frequency plate-current swings, which go to high values and cause much power to be drawn from the supply, as evidenced by the high average (d.c.) plate current. Nearly all must be dissipated within the tube, only the relatively small second harmonic portion being drawn off into the load.

A New Development

A remarkably simple method of changing this unfavorable state of affairs was disclosed some time ago.* Using it, the doubler output is raised until it is almost equal to what the tube is capable of delivering as a straight amplifier. That is, the efficiency is so greatly increased that it is possible to use a much higher plate voltage, without overheating the plate, and with a great increase in output. Sufficient power may be obtained to make superfluous a following amplifier tube of the same size, as not much more output will be obtained by using one. This means that it now becomes perfectly practical to work the doubler right into the antenna, or that one or more intermediate amplifiers can be eliminated where a larger tube feeds the antenna.

Thus, it is possible to build a two-tube (crystal oscillator and doubler) 7 mc. transmitter of high efficiency, using a 3.5 mc. crystal (or a two-tube 14 mc. rig with a 7 mc. crystal). Anyone who has used multi-tube outfits on any frequency will realize what a simplification of plate-supply and grid-bias equipment this means, to say nothing of the r.f. apparatus and its adjustment. And to top it all off, the new circuit is formed by removing apparatus from the conventional circuit.

*E. G. Watts, "Improvements in Frequency Multipliers for Aircraft Radio," *Electronics*, April, 1932.



It has been found possible to more than double the usual efficiency obtained in ordinary doublers. This means a great increase in output, when the plate voltage is raised to give the same plate heat. A 210 tube can be operated with 600 volts on the plate, 40 watts input, with no trace of plate color.

Operation

The operation of the new system is based on the discovery that the commonly used neutralizing circuits reverse their usual function and *supply* regeneration when used in frequency multipliers. Not that regeneration in a multiplier is anything new. The Naval Research Laboratory has taken advantage of it for some time. They discovered that it greatly improves the efficiency. But it was not possible to obtain sufficient regeneration without introducing serious disadvantages. The new circuit eliminates the disadvantages, and in doing so, finally makes entirely practical the use of regeneration for improving the efficiency of frequency multipliers.

Before going into instructions on how to change over an ordinary doubler for operation by the new method, first a word to allay the fears of those who think of regeneration only in the same breath with instability. It is true that many schemes based on regeneration have been proposed for getting a lot of power out of a crystal oscillator, or power amplifiers, that are very tricky to adjust, with disaster for the crystal as the penalty for a misstep. The new doubler system has nothing in common with such schemes, for two reasons. First, the point of maximum improvement is reached without approaching closely the point of instability. Second, the regeneration takes place at the harmonic frequency only, and not at the crystal frequency, so that the effect on the crystal of a possible "spillover" into oscillation by the doubler would be slight. Moreover, the adjustment of regeneration is so positive and un-critical that no difficulty is experienced in holding the regeneration exactly where desired. When properly constructed, the system is entirely stable, and no difficulty is had in making things "stay put". The writer has observed several of these doublers operate for two years with no attention. This is no reason to believe that they are any less stable and reliable than ordinary doublers; indeed, they are much less likely to overheat the tube dangerously as a result of some disturbance in the circuit, or even while being adjusted. The system is de-

cidely not a "trick" affair; exact figures can be given for its construction and adjustment.

In order to get a clear understanding of what goes on in the new doubler circuit, and so to be able to adjust it intelligently, let us consider a few things about multipliers in general, with particular reference to the effect of neutralizing circuits. There has been much

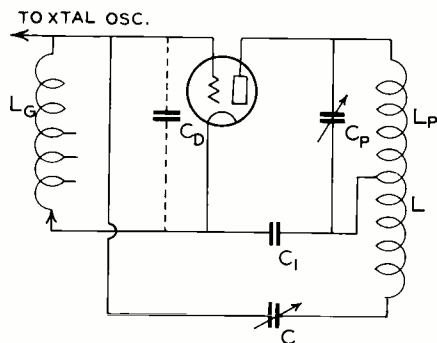

Figure 2

talk about whether or not to neutralize a frequency multiplier. Sometimes the statement is made, correctly, that neutralization is not necessary. But the reasons why it is unnecessary have never, to the writer's knowledge, been correctly given. In spite of the wide difference between the frequencies to which the plate and grid circuits are resonant, a doubler *will* regenerate (through the tube capacitance, as in a t.n.t. or t.p.t.g. oscillator) and may even oscillate at the fundamental or grid circuit (preceding tank) frequency, when no excitation is applied. The reactances have the sign required to cause regeneration, and it is only a matter of the plate tank having a high enough L/C ratio to give sufficient impedance to sustain oscillation, in the absence of the external excitation.

But under no conditions can an ordinary doubler become unstable (that is, tend to break away from control by the excitation) with the excitation applied for several reasons. First, the external excitation completely swamps out the internal, which is much smaller because of the low impedance of the plate tank to the fundamental. The output frequency is therefore always exactly that of the external excitation. Second, regeneration at the plate circuit frequency can not take place. The grid circuit (preceding tank circuit) reactance is of the wrong sign at this frequency. This is clearly evidenced by the fact that oscillation always occurs at the grid circuit frequency, and is almost completely unaffected by the tuning of the plate tank, when the latter is resonant at con-

siderably higher frequencies. (To be exact, the oscillation frequency is always slightly lower than the actual grid circuit resonant frequency, to give the required reactance sign.)

But what is more important than any of this is the fact that, in addition to being unnecessary, neutralization of a doubler by the usual

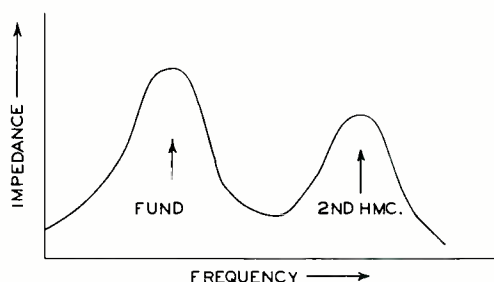

Figure 3

means is *actually not possible*. If an attempt to neutralize is made, none of the usual signs of the neutralized condition can be found. In their place, a new set of "symptoms" has appeared. Among them is an increase in output at some setting of the neutralizing condenser. In most cases it has probably been assumed that this is an indication of the neutralized condition. What has actually happened is that the neutralizing circuit is causing regeneration. This is because the neutralizing circuit reactance is opposite in sign at the second harmonic (plate tank frequency) to what it is at the fundamental or grid circuit frequency, and this causes the feedback current to *aid* the output instead of bucking it, as in an ordinary neutralized amplifier.

Evolution of the Circuit

Not much regeneration can be obtained with the neutralizing circuit alone, however, even at its best adjustment. After he ascertained that regeneration was occurring, the job the originator of the system had was to find out what was limiting it. Let us look at the matter as it appeared to him. Figure 1 is the usual amplifier-doubler circuit, with Hazeltine-type "neutralization". Note that the neutralizing or feedback circuit, as we should now call it, which consists of L and C, is connected across the grid and filament (coil L being connected to the filament through bypass condensed C_1). Now, the feedback voltage is induced into L through its coupling to L_p , and is impressed from the grid to filament across L and C. Also across from grid to filament is the plate tank of the preceding stage ($L_g C_g$), from which the fundamental frequency excitation is obtained.

Consequently, the second harmonic feedback voltage is nearly shorted out. We must raise the impedance of the tank $L_g C_g$ at the second harmonic, although leaving it tuned to the fundamental, if the regeneration is to build up sufficiently.

A combination of fortunate conditions enables us to do a very efficient job of this impedance-raising; one which involves no compromises among desirable, but conflicting, conditions. Watts first tackled the problem from the angle of raising the L/C ratio as much as possible. Those who have neutralized by the Hazeltine circuit will recall that the neutralizing condenser affected the tuning of the preceding tank, and that each time the neutralizing condenser was changed, the preceding tank had to be retuned. It is easy to see that the neutralizing condenser is effectively in parallel with the tank (with coil L and a couple of condensers in series, perhaps, but that does not alter the essential fact). We want to keep the L/C ratio as high as possible, but here are two condensers in parallel; so why not remove one of them? We discard C_g , and find that we can increase L_g considerably, and that condenser C tunes it to the fundamental just as well as C_g did. C can be made to perform the dual function of feedback control and tank tuning condenser without detriment to either adjustment, because the feedback setting is not at all critical, and does not resemble the neutralizing adjustment in the least. We now have a nice high-L/C tank, and have done away with one condenser to boot.

But even so, we have yet more than this. The performance of the circuit, now as in figure 2, indicates that much more regeneration is being obtained than could be accounted for by the higher L/C ratio alone. Investigation reveals that some unexpected conditions exist as a result of the elimination of C_g . If we draw a graph, with the impedance across L_g plotted against frequency, we find that after we pass the peak due to the fundamental resonance, as the frequency goes up, *the impedance rises to another peak at a higher frequency*, somewhat as in figure 3.

We have now arrived at the heart of the new system. The grid circuit, composed of L_g , C, and L, together with C_1 (see figure 2) which represents tube interelectrode and circuit wiring capacitance, has two anti-resonant points. The lower of these is tuned to the fundamental by adjusting C. The other may

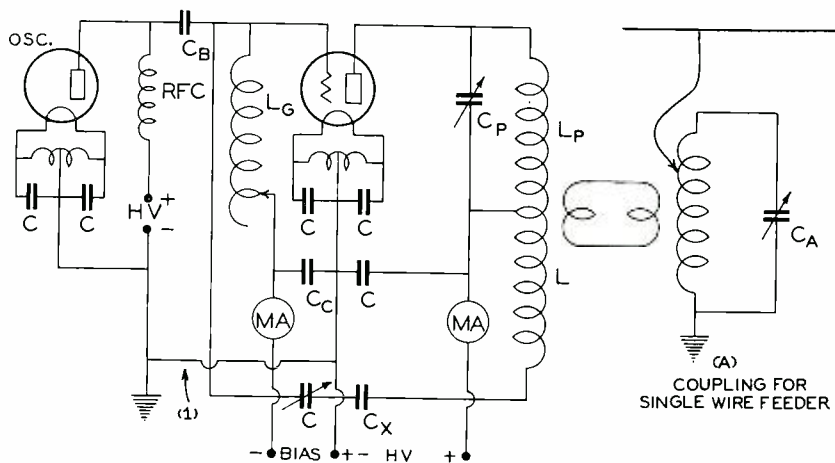

Figure 4
Basic circuit for the high-power two-stage transmitter.

be tuned to a frequency near the second harmonic, thereby raising the impedance of the grid circuit at the second harmonic, and permitting sufficient voltage of this frequency to be set up to cause the desired amount of regeneration.

Let us now see how we may tune the circuit so the second resonance peak is at a frequency giving a suitable amount of regeneration. The lower peak must remain tuned to the fundamental, of course. The cause of the double resonance is that the combination tuning and feedback condenser C has the coil L in series with it before it shunts L_g . At the fundamental frequency, L has little effect, so C is practically the same as in direct shunt with L_g , and tunes it to the fundamental. But at the second harmonic, L completely overshadows C and causes the effect of the two in series to be the same as an inductance shunting L_g , instead of a capacitance, as at the fundamental. Now two inductances in parallel are equivalent to an inductance smaller than the smallest of the two. Consequently the effective inductance in the grid circuit at the second harmonic is only a fraction of L_g , since L and C in series have an equivalent inductance of only a fraction of L_g .

Now note (figure 2) that the only capacitance directly in shunt with the grid circuit is C_{i1} . This, being composed of the relatively small tube capacitances, plus the still smaller wiring capacitance, and distributed capacitance of L_g , is very small compared to C . Consequently, with C_{i1} in combination with the smaller effective inductance, the resulting resonance falls at a frequency considerably higher

than the fundamental, when C is set to tune L_g to the fundamental.

We can vary the frequency of this higher resonance independently of the lower one by changing the inductance of L_g . It is necessary to reset C each time L_g is changed, so as to keep the lower resonance at the fundamental, but changes in C have only a slight effect on the frequency of the higher resonance, and it remains quite close to where it is set by L_g . That is, L_g affects both resonances, and C compensates for the lower one but not for the higher. This adjustment of L_g is the main-spring of the new system. We can now forget that C does anything besides tune the grid circuit to the fundamental.

Construction

In changing over an ordinary doubler having no neutralizing circuit, it is first necessary to add the extra turns for L , which are the same in number as in L_p . It is best to keep L_p as large as possible, consistent with a workable value of C_p ; so rather than use the coil formerly used for L_p by tapping it in the middle, a new coil of twice the size or larger should be used. Specifications for suitable coils are given in the table for 7 and 14 mc. operation. The size is not critical, nor is the accuracy of the center tap. In general, the larger the coil's dimensions, and the less insulating material used to support it, the more efficient it will be. The writer prefers a flatwise-wound strip for the conductor. This may require more supporting structure than tubing, but any increased loss on this account is less than the loss due to the disadvantages of the tubing.



TABLE I

Coil	Taps	Conductor	14 mc.				7 mc.			
			Dia.	Length	Turns	Induct.	Dia.	Length	Turns	Induct.
L _p -L	Center	Strip or Tubing 3/16"- 5/16"	5 "	5 "	12	12 μh	3 3/4"	4 "	10	6 μh
		No. 12 or 14 wire	4 "	4 1/2"	14	"	3 "	4 "	12	"
L _g	Ea. turn for 14 turns	No. 14 wire (Sp. Dia. of wire)	3 1/2"	2 1/2"	22	40 μh	2 1/2"	2 1/2"	22	20 μh

For those who are not inclined to make the large coils, data is also given for coils of no. 14 wire, which may be wound on tubing of hard rubber or some low-loss composition. Bakelite is not suitable at the higher frequencies.

L_g is too large in inductance to be conveniently made of anything but wire. Its efficiency is not so important; it does not directly affect the output as L_p-L does. The many taps are made necessary by the possible wide variation in conditions affecting the capacitance C_d in different sets, which must be allowed for. These taps are easiest made by crimping up the wire as the coil is wound, to provide projections for a clip. The crimps should be staggered on adjacent turns so they do not come too close together.

Condenser sizes are given in figure 4, which is the basic circuit for a two-tube frequency-doubling transmitter. C may have a maximum capacitance of not less than 100 μμfds., and not more than 150 μμfds. The larger capacitance is more likely to be needed for 14 mc. operation, as L_g may have to be quite small to reach the best regeneration point. Ordinarily C will be set to from 70 to 90 μμfds. for 7 mc. operation. Note that both sides of C are at r.f. potential above ground. This will cause hand capacity and tricky tuning of the crystal oscillator unless an insulated extension shaft is used.

When the plate voltage on the doubler exceeds 500, C should be double-spaced, and the fixed condenser C_x inserted to remove the d.c. plate supply voltage from across C. The r.f. voltage across C may be quite high, and without C_x a flashover would short-circuit the d.c. supply. C_x should have a rated working voltage in excess of the plate voltage.

A grid milliammeter in the doubler is a great help in keeping the crystal oscillator tuned for maximum output, as indicated by maximum

grid current (for a given doubler bias). A doubler plate milliammeter is not essential, but will be a help in getting the doubler into tune, and in obtaining maximum efficiency. The output indicator may be either the grid milliammeter of a following stage or the antenna meter. If one is not "long" on meters, especially the expensive r.f. variety, it is perfectly feasible to do the job with a flashlight bulb (shunted if necessary) in series with the antenna.

If a single-wire feeder antenna is used, best results will be had if the feeder is coupled to the doubler by a tank, as at (a) in figure 4. The coil may be the same size as L_p-L.

The lead (1) connecting the filament center-taps should not be any longer than necessary. All bypass condenser leads should be kept as short as possible. L_g should be a foot or more from L_p-L, and set at right angles. The diameter of the r.f. choke, if a solenoid, should not exceed 3/4". Its characteristics should be suitable for operation at the crystal frequency. It is well to try several chokes of somewhat different characteristics in the transmitter.

The filament transformer bypass condensers may not always be necessary. In fact, they may sometimes be found detrimental, especially at 14 mc.

Triode, screen-grid or pentode tubes are all suitable for the doubler. If one has the choice, it may be found that some one type gives better results than the others. Pentodes generally make the best crystal oscillator. Low amplification-factor tubes such as the 245, 250, or 2A3 should be avoided.

In the doubler, the use of screen-grid, or pentode tubes with grid and plate leads isolated (the 247, 2A5, and others do not have them sufficiently separated) has the advantage that the stage may be changed over for straight-amplifier operation without neutralizing. L_p needs but to be replaced by a coil of suitable size for the frequency used. [Cont. on Next Page]

Power Supply

In any transmitter it is always desirable to use a separate plate supply for the crystal oscillator. With the new doubler, owing to the higher plate voltages it is possible to employ, a rather high grid-bias voltage source is required, and this is easily obtained from the crystal oscillator plate supply, by grounding the "plus".

As in an ordinary doubler, the bias voltage must be high—from 1/3 to 2/3 the plate voltage, depending on the tube used. Tuning up may be done with any bias value high enough to keep the plate current at safe values, but yet low enough to give good indication on whatever output indicator is used, and the final adjustment of bias for maximum output made after other adjustments are completed.

When the plate voltage is high for the tube used, e.g., 600 volts on a 210 or 247, or 1200 volts on a 203-A or 211, it is best to reduce the voltage when tuning up by inserting a resistor of 4,000 to 8,000 ohms in series with the plate supply. Also, if the doubler is not keyed, a switch should be placed so as to turn off the doubler plate supply independently of the filament and the crystal oscillator supplies so that the latter can be tuned for maximum output before the doubler is adjusted. The only case where the doubler is not keyed will be when a following amplifier is used, in which keying or modulation is done, the doubler being allowed to run steady. It is usually not practical to key any kind of doubler in the grid circuit on account of the high blocking bias required; so it is simplest to key in the plate supply circuit. Less trouble with click interference will usually be had by keying the primary of the plate supply transformer. Very little filter is required to obtain a pure d.c. note, as with all crystal-controlled transmitters; and keying at this point will be clean cut if not too large a filter is used.

HAM HINTS

Suppressing the Second Harmonic

By JAYENAY

Several stations troubled by a bad second or fourth harmonic are using the simple dodge shown herewith. This use of a resonant transmission line has practically no effect on the fundamental but effectively short circuits the even harmonics. The line is cheap and can be run in any convenient direction. It can be run around and around a room. The idea

is simply that each leg of the line is a quarter wave at the operating frequency. Thus the total length is a half wave and it represents a high impedance to the fundamental. However, it acts as a direct short circuit to even harmonics and thus they never get a chance

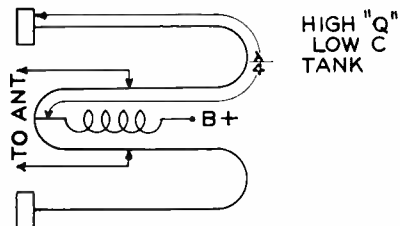
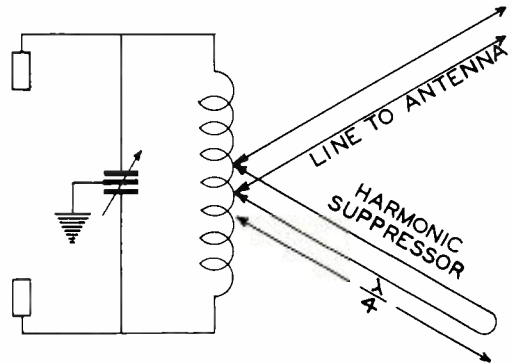

to get started on their way to the antenna. This type of filter is particularly useful for the high power man who wants to avoid the expense of the variable condensers necessary for the π type of harmonic filter. Incidentally, this long line can replace the plate tank with extremely good results. The center of the far end is practically at ground potential, as far as r.f. is concerned, (assuming a push-pull final amplifier) and the d.c. plate voltage can be series fed at that point. Wire is certainly cheaper than tank condensers, particularly at high voltage. While this is a very low C type of tank its high Q makes it useful for modulated amplifiers, and the losses are quite low. The transmission line to the antenna can be tapped on close to the short-circuited end and the taps varied until the amplifier draws the proper load.

Again, we point out that there is nothing new under the sun—Fessenden was using vertical pipe antenna in 1905.



Some Notes on Grid Excitation

By JAYENAY

At this time of year most hams are thinking about designing their transmitter for next year, although they probably will not commence reconstruction until after the winter and spring dx season is over. The most important and fundamental consideration when designing a transmitter is to provide just enough power gain through each stage to excite properly the final amplifier. If there is not enough grid excitation along the line, each stage that has insufficient excitation will be lacking in output and plate efficiency which results in a cumulative lack of performance. Quite often, a slight change in one of the very low power stages will give enough increased output to the following stages materially to improve the performance all along the line.

It is necessary to appreciate the fact that there are two separate and distinct sets of optimum operating conditions for every tube. One set of conditions is for *maximum power output* and the other set is for *maximum power gain*. Usually buffers and doublers are operated for maximum *power gain*, while only the final amplifier is operated under the rather extreme class C conditions that give *maximum power output* but at a great sacrifice in power gain.

The main difference between the two sets of optimum operating conditions lies in the adjustment of the negative grid bias and the coupling to the next stage, or load. For maximum power gain the bias is usually low, between cut-off and about one and a half times cut-off. The coupling to the load is quite tight and the plate efficiency runs between 50% and about 66%.

For maximum power output the bias usually runs from twice cut-off bias to three or four times cut-off, depending on the transconductance of the tubes used. The coupling to the load is looser and the plate efficiency may run anywhere from 66% to 85%. The required grid drive for maximum power output may be six times as much as is required when the tube is operating under conditions of maximum power gain. However, the power output may be twice as great.

Thus it is desirable to consider just what some of the common tubes will do under var-

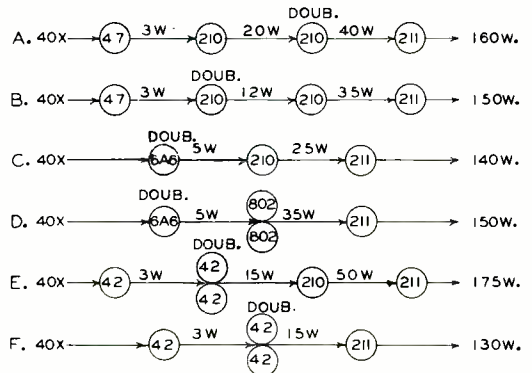

ious conditions of voltage, bias, grid drive and frequency.

There are certain relationships between the various operating conditions and the output of a stage that should be kept in mind.

The higher the frequency the harder a tube is to drive to a given power output. In other words, the power gain goes down as the frequency goes up. The power gain through the high C tubes such as the 203-A and the 211, etc. drops much faster than the gain through the low C tubes such as the 52, 50T, 852, 354, 150T, HF200, etc. as the frequency is raised. At frequencies around 4 megacycles there may not be much difference between a 211 and a 150T, as far as power gain is concerned. At 30 mc. however, the 211 is practically incapable of any gain at all, while the tubes in the second group are still capable of showing considerable power gain, though much less than at 4 megacycles.

The higher the plate voltage, the higher the power gain and also the higher the plate efficiency and power output. It generally pays to use as high a plate voltage as possible, up to the point where the transconductance stops increasing. This occurs at about 1100 volts on a 210, about 3000 volts on the 203A, 211, 50T, 150T, 354 and the HF200. However, insulation limitations prevent using the 210, 211 and 203A at the most desirable value of plate voltage. The 210 starts to get very "unhappy" above 750 volts while the 211 and 203A types are apt to arc over above about 1650 volts of unmodulated plate voltage. If these tubes are



to be modulated the plate voltage would have to be cut down considerably.

The higher the grid bias the higher the plate efficiency, but the output drops off unless the grid drive is materially increased at the same time.

The looser the coupling to the load the higher the plate efficiency, the lower the power output, and the lower the power gain becomes.

As with everything else, a compromise of a number of conflicting factors must be established. The best possible compromise can only be established when the operator has a good understanding of the fundamentals involved.

Every so often, this magazine, and undoubtedly other amateur technical magazines, receives inquiries from a reader asking that a table of tube data be given showing just how much output and power gain accompany various sets of operating conditions. This sounds rather simple. All that are necessary are several experimental stages and some calibrated r.f. resistors to measure the r.f. output. The drawback is that small differences in construction make such wide differences in performance that the average error in such a tabulation of power gain and power output could easily be as much as 200%. Thus such a table would be a handicap instead of a help.

There is no doubt that if ten amateurs were asked to design a radio frequency exciter to drive a 211 on 20 meters, starting with a 40 meter crystal, in a few minutes there would be ten entirely different exciter circuits drawn up. No two would resemble each other, and a grand argument would start: Tritet against Jones' 53; 47-46 against Harwood's 42-42; RK20 against push-pull 802s, etc. Thus it would go on, far into the night. Who is right? No one can possibly tell, until somebody sits down with a pencil and a mail order catalogue and starts determining the cost in each case. Even that procedure is hardly fair because no two of the ten amateurs will agree on how much grid drive the 211 should have on 20 meters; so each exciter will have a different output.

After a great deal of cut and try and an attempt to make up a table of power gain and power output with an experimental transmitter using a 211 in the final amplifier operating at 1300 volts on the plate, the project was finally abandoned, as the results were so erratic. However, the results of some of the tube line-ups are shown, and may be interesting; but please

remember that experience shows that anyone who attempts to duplicate these results may get widely varying results.

All the transmitters used link coupling between all stages, in order to allow the widest possible adjustment of plate loads. All stages used the same 40 meter crystal and the three power packs used gave approximately 375, 650 and 1500 volts. The 47, 42's and 6A6 all worked at 375 volts. The 210's and the 802's all used about 650 volts and the 211 ran at 1300 volts.

In the figure, "A" is the first set-up. The sketch should be self explanatory. The first 210 is a buffer on 40 and the second 210 doubles to 20 meters. At "B" the same set-up is shown except that the first 210 doubles to 20 while the second 210 is a buffer on 20. As the 210 has materially less power gain on 20 than on 40 it is seen that slightly better grid excitation for the 211 is obtained by doubling in the second 210, as in "A".

At "C" is shown a 6A6 doubling to 20 in the second triode section of the 6A6 and driving a 210 buffer on 20. Note that the 210 output with only 5 watts of grid drive is only a little less than with 12 watts drive.

In arrangement "D" is shown a 6A6 doubling to 20 and driving parallel 802's on 20. This line-up gave about the same results as the 210 combination in figure B and not as good results as figure A, even though the cost of the 802's is materially higher than 210's. It should be noted that the 802's showed quite a bit of regeneration on 20 meters, and extensive shielding had to be used to stabilize the stage.

In figure E is shown the 42 exciter, similar to the Harwood exciter shown on page 10 of the December, 1935 issue of *R/9*.

The first 42 is a standard oscillator and the doubling is done in the parallel 42's as used here. These tubes are quite cheap and rugged and will find wider use soon. The 210 is a neutralized buffer on 20.

In figure F the two 42 doublers were used to drive the 211 directly. This set-up has only five tuned circuits against seven tuned circuits for all the other arrangements. The figures between each stage refer to the power output measured at that point. The output measurements are accurate to about 10%.

It must be emphasized that other experimenters may find that their results contradict mine. This will be no news to me as I have already tried to duplicate these experiments and have,



in some cases, contradicted my own results. Many other tube combinations were tried but are not shown because of highly uncertain results.

On the basis of output watts per dollar the set-up of figure F had the others beat because of the use of only two power supplies, only five tuned circuits, (only three tuned circuits would be necessary with capacitive coupling) and low cost tubes except for the 211. However, the transmitter of figure five also had the lowest power output.

After many attempts to get an exciter lineup that was efficient and economical for three band use, the writer decided to use two separate exciters, one for 80 and 40, and the other permanently left on 20, as 20 is the critical band. The first fifteen watts are the hardest to get.

In general, the main compromise in the average amateur transmitter is either to use a lot of stages using small, cheap tubes, or to use a few stages using big, expensive tubes as buffers in order to get high power gain per stage by sacrificing efficiency in these stages for the sake of output.

◆ Inexpensive Crystal Mike

Harry Hurley, W6QF, reports that he and several other amateurs are having great success with a microphone made from one earpiece from a Brush crystal headset. This is about the cheapest crystal mike one can use. All of the amateurs trying the idea were able to get surprisingly good quality, Harry reports. The only precaution that must be observed is the complete shielding of the unit, and the use of a shielded connecting cord. Most any kind of screen may be used for shielding the unit, just so the mesh is not too large.

This idea of using a crystal headset for a microphone first appeared in R/9 several months ago. Any conventional type high-gain amplifier may be used. W6QF feeds his into a 6A6 working in cascade as a preamplifier.

◆ Annealing Brass or Copper

In working brass or copper, it will become hard, and if hammered to any great extent will split. To prevent cracking or splitting, the piece must be heated to a dull red heat and plunged into cold water; this will soften it so it can be worked easily. Be careful not to heat brass too hot, or it will fall to pieces.—W6DOB.

◆
"All's fair in love, war, and the dx contest!"

Looking Over the Canadian "Regs"

By RUFUS P. TURNER

The writer became inquisitive regarding amateur radiophone regulation in Canada as a result of a bit of second-hand information. A visiting VE had remarked that the Canadian authorities are as strict as a Yankee schoolmaster where ham phone is concerned, and this dovetailed very nicely with the writer's observation that VE phones have a habit of sounding good. It was decided forthwith to secure first-hand knowledge of the matter; so a copy of the Canadian amateur regulations was obtained from the Department of Marine, Radio Branch, Ottawa.

The booklet revealed the following information of interest to U.S. radio amateurs. In Canada, radiotelephone operation is authorized in the bands 1775-2000 kc., 3500-3550 kc., 3850-4000 kc., 14,100-14,300 kc., and in 5, 10, and 3/4-meter bands identical with our own. The restricted bands are 3500-3550 kc., 3850-4000 kc., and 14,100-14,300 kc., comparable to our 75-meter and 20-meter restricted phone bands. Canadian hams who desire to use telephony in these bands must have held a Canadian license for at least two years, "during which period his station shall have been in active operation on either c.w. or telephone." And he may not commence operation until a *visiting Inspector has checked the transmitter in operation* and so endorsed the license. We are advised that this inspection is most rigid. In this respect, the VE's have a tougher time of it than do we in the United States getting phone authorization in the restricted bands.

Quoting Mr. C. P. Edwards, Canadian Director of Radio Service, "The rules governing radiotelephone transmission in these bands have been laid down on the basis of representations made by organized amateurs in Canada and appear to have had the effect desired both by the Department and the amateur fraternity as a whole, namely of raising the standard of the initial installation of equipment at such stations."

It is also a matter of interest that Canadian hams are charged for their licenses at the rate of fifty cents for an operator's certificate and \$2.50 for a station license.

◆
The word *radio* was not included in the New Standard Dictionary until 1923. It appeared in the addenda of new words in Webster's in 1913.

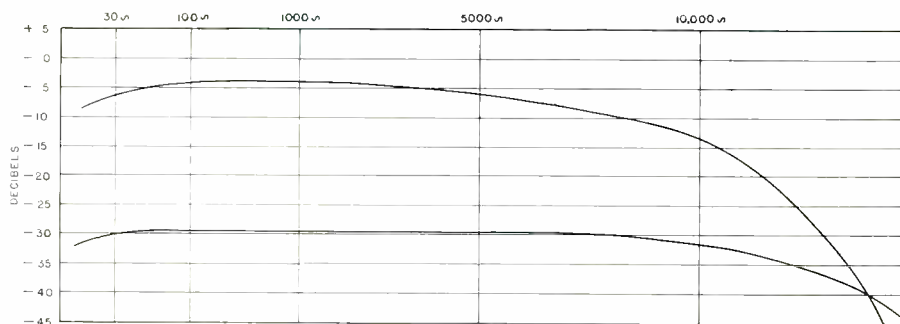

Figure 3
Response curves. Lower curve is for the single-stage amplifier. Upper curve taken with the two-stage experimental amplifier.

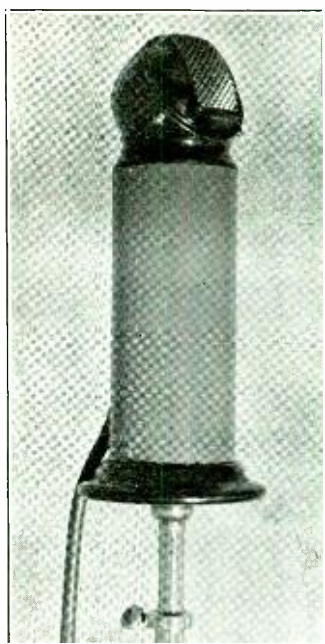
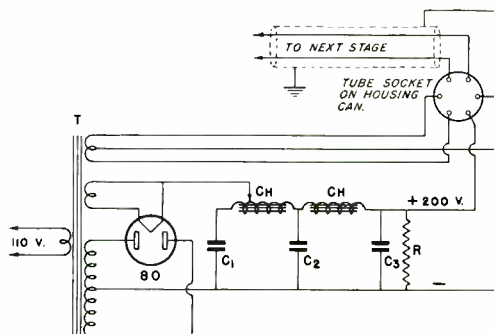

Figure 2
The Finished Condenser Microphone.

terminal strip similar to those used in radio receiving set construction. This makes an excellent cable terminating strip, and when it becomes necessary to replace worn-out microphone cables, such an accessible solder terminal strip is fully appreciated.

The condenser head receptacle is of cast aluminum and was built to specifications by a local pattern shop. This receptacle fits tightly into a 12" length of 3 1/2" diameter aluminum tubing. This housing fits down over the amplifier, and when fastened to the base by three wood screws, comes in contact with four small copper grounding strips, thus completing the ground connection to the condenser head.



- Power Supply**
- C₁—1 μfd.
 - C₂—8 μfd. electro.
 - C₃—16 μfd. same
 - R—75,000 ohms
 - Ch—20 hy.
 - T—Midget power trans.

The grid lead is drawn through a small hole in the aluminum casting and is connected to the back of the condenser head by means of a wafer tube socket.

[Cont. on Next Page]

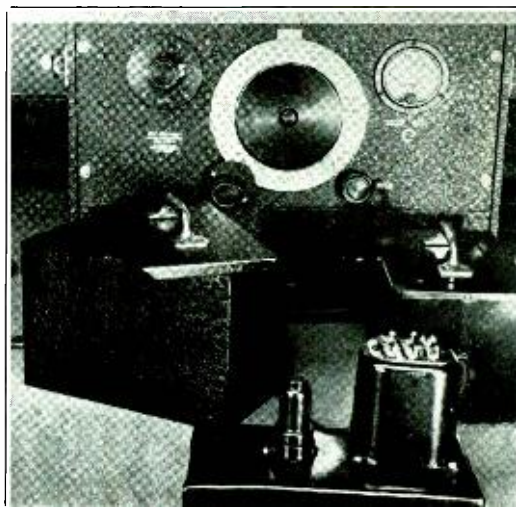

Figure 4
Crystal microphone amplifier shown with power supply. Beat frequency oscillator in background.



The condenser microphone described has been in active service for three months and has given excellent service under the most severe conditions.

The small, compact amplifier with its associated power unit shown beside the beat-frequency oscillator in figure 4 is, except for mechanical construction, essentially the same as the condenser head amplifier just described. This unit is used as a pre-amplifier for a diaphragm-type crystal announcing microphone.

If higher gain is required and a less desirable frequency response can be tolerated, the 6F5—6C5 two-stage resistance-coupled combination makes an efficient amplifier. Quite a loss in the higher frequencies has been experienced by the use of high-gain tubes. This type of amplifier finds its application in cases where the microphone itself has a decided rising output characteristic at the higher frequencies.

A suitable power supply for the single stage amplifier is quite simple and inexpensive to construct. The low current consumption of the 6C5 permits the use of the smallest of power transformers and chokes.

The filter system should consist of at least 24 μ fds., and the use of a tuned choke with a 1 μ fd. condenser does much to cancel 120-cycle hum.

Care should be taken in selecting a microphone cable (or cable connecting the amplifier to its power supply) as a small 60-cycle a.c. field surrounds the 6.3 volt filament supply leads, and at extremely high gain it is capable of a very slight 60-cycle modulation. This is eliminated by using a special cable with a separate pair of shielded leads in it, or by using two separate cables.

For ordinary use, however, the hum from a twenty-five or thirty foot, five-wire shielded cable is so low as to be entirely negligible.

Hiram Percy Maxim

His end came at LaJunta, Colorado, on Monday, February 17, 1936. He was born in Brooklyn, N.Y. on September 2, 1869. In the 67 years spanned by those two dates Hiram Percy Maxim touched upon, and influenced vitally, an astonishing array of fields, not by any means all of an engineering nature such as would be premised from his education at Massachusetts Institute of Technology, or his relationship to those other Maxims who devised explosives and machine guns.

Indeed his earlier work had to do with elec-

trical matters altogether, with the usual variety of "jobs" that the young graduate sees. In 1895, however, he became engineer for the Pope Manufacturing Co., and later for the Electric Vehicle Co., both makers of "horseless carriages". Those who knew Mr. Maxim will remember with pleasure his tales of the fantastic struggles of the early auto-maker and driver, unaided by proper steels, fuels, lubricants or roads. Few remember the Westinghouse Electric and Manufacturing Co. as even remotely interested in automobiles, yet for two years Mr. Maxim was their "Vehicle Motor Engineer".

The Maxim gun-silencer, though it produced a great deal of publicity, never became the important article of manufacture that had been hoped when the Maxim Silencer Company of Hartford, Connecticut, was formed. Adverse legislation gradually drove it from the market and the firm turned to industrial silencers and lately to street-noise filters to be used in office windows. In later years much of the design work on these devices was due to Roland B. Bourne.

These vocations have, throughout Mr. Maxim's life, been overlaid with a series of avocations, in many of which Mr. Maxim's energy and eagerness produced major changes. Of them but a few are to be named.

Of late years his outstanding hobby was amateur moving picture photography, characteristically formalized into a league of amateur cinematographers. This interest, and the lessening energies of an aging man, gradually displaced amateur radio communication as an active interest.

Whether it was a kindness to amateur radio to organize it as a message-handling network, and thus for a time to change its form, one cannot say. However one can observe that the difficult days of amateur radio communication began while Mr. Maxim was gradually withdrawing from an active part therein. As that withdrawal proceeded he was obliged to rely increasingly upon hearsay information, necessarily derived in considerable part from the employees of the American Radio Relay League. The financial interests of these employees must thus have colored his view of amateur radio and it would be unfair to the memory of a brilliant gentlemen to blame him for certain acts and sayings of recent years. That he was gravely misled does not in any degree cause shadows to be cast on the intentions of Hiram Percy Maxim.



28 and 56 Megacycle Activity

[Reports and other material referring to the 28 and 56 mc. bands, should be sent to E. H. Conklin, W9FM, Assistant Editor of RADIO, 512 No. Main St., Wheaton, Illinois, who will correlate and assemble the data for publication. Reports should reach him by the 22d of each month.]

28 Megacycles

Last month we received a "Success Story" from a well-known dx man, Harry Burnett of W1LZ, which gives a nice picture of ten meter conditions as compared with those of other bands:

"... Your enthusiasm finally spurred me on to try the band myself. Employing your data on best times for dx and your list of dx

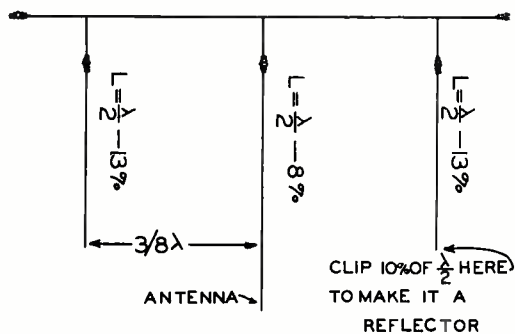

Reversible end-fire array used with success at W9FM. By clipping on 10 per cent of a half wave to either director, it becomes a reflector. To "squirt" signals in the opposite direction, take off the 10 per cent and clip it on the other outside wire. The $\frac{3}{8}$ wavelength spacing between elements is not optimum for maximum efficiency, but is rather a compromise. In spite of this, very good directivity is obtained with the arrangement.

stations' frequencies, I was amazed to discover what could be heard and worked with simple, mediocre equipment. I used a two-tube autodyne receiver. 100 watts on a 242A doubler in the transmitter worked into a 67-foot zepp. The old timers on 28 mc. tell me that conditions were only fair, but in the week from January 26 to February 2, I worked 31 of the 52 stations, heard—including all continents except Asia.

"Apparently it takes but very little to go a long way on this band. The reports received are of the type that one would get only when 500 to 1,000 watts input is used on '20'. . . . Keep up your good work of popularizing the band, o.m. There are plenty of laggards, like myself, who need a few more gentle nudges to send them down to the 'new twenty meters.'

The boys with QRP and patience should find it a veritable paradise for c.w. or phone."

Reports on Conditions

To summarize the reports received up to March 1, 28 mc. has continued satisfactory for dx, though with little heard from Asia except on the west coast. G6DH worked W's every day for *two months* and was still at it by the beginning of February. We asked W9JGS what days were dead for dx, but on inspecting his log, we found no dead days since early last fall. 1500 to 2000 mile skip was the rule, but on some days it dropped to 400 miles, such as on January 19 when a Milwaukee station heard a W1 on 56 mc. The 28 mc. band continued to be the best for working the west coast from Illinois. Here are the individual observations:

G5LA: Conditions during January were about the same as in December, except that more have been heard of the elusive Asians. North American stations have come through regularly in the afternoon every day. Two new countries have been contacted, G6DH working VO1N for the first VO-G contact, and G2YL worked GP1AC for the first CP-G contact. G6LK worked VO4Y. Congratulations to G6DH who is now W.A.C. and W.B.E. on 28 mc.; he heard VU2BL on January 18 but did not manage to hook up with him until January 28; this month G6DH has worked W, VE1, VE2, VE3, VP5, ZS, EA, OH, ON, SU, LU, ZE1, VK1, VK2, VK3, VK4, VK5, VK6, and has heard VU2BV and VP2BG. G6WN worked VU2BD and now requires VK or ZL for W.A.C.; he finds that he cannot hear VK well although signals from other parts come in well. BRS1847 hears W6CNE (phone) and W6DIO as well as numerous nearer stations.

CP1AC: Using 350 watts on an 860 on "ten". The band is open from 7 a.m. to 10 p.m., e.s.t.

I2HJ: Has been ill but active again, using 500 watts to a pair of "50 watters".

W2DTB: Band conditions have been rather poor here. No J's lately. South Americans are the most consistent with LU9AX in the lead, coming through any hour of the day from 8 a.m. to 8 p.m., e.s.t., but peak around noon and 6 p.m. The Africans have been quite good; ZS1H averages R6-7 from 8:30 a.m. to 1:00 p.m., best around noon. FA8BG, ZS2A and CT3AB have been in for the same periods. The Europeans have been very spotty and do not stay in for any great time. EA4AO sometimes pounds through R9 when the rest of the gang are down in the noise level. On February 16, G5PB was heard R6 around 4:00 p.m., which is unusually late; this particular day happened to be very poor for Europe but fair for Africa and South America. In three months I have had 275 foreign contacts in over 30 countries.

W3AIR: VK signals are now peaking at 2200 G.m.t.



all weak with conditions like summer except in the morning when plenty of Europeans still come through (on 4-in-phase beam). Each day 5 continents can be heard and worked but still no J's break through the auto QRM. ZS2A, ZS1H and FA8BG still rocking through.
Best times for January:

Australia	2145 to 0115 G.m.t.
So. America	1600 2300
Europe	1300 1830
Africa	1345 1800
No. America	daylight darkness
Asia	A riddle to be solved.

Schedule contacts in January with VK3YP and G6DH on the directional antenna total 14 with each station, at 2200 and 2400 G.m.t. with the Aussie, 1350 with the G. Three scheduled contacts were held with OA4B at 1600 and 1715 using a vertical 60 foot antenna. Still using a pair of 830B's in the final, modulated with a pair of 46's. Heard 79 dx stations in January, worked 38 of them, some a number of times.

W'3SI: In January, 28 mc. was consistent for W stations but the dx suffered. Europe is still good for about an hour in the morning but the other continents are haywire. The new 1 k.w. rig is perking and is ready for anything.

W'8MAH: When I am on 28 mc., I hear Europe well. The last "G" QSO I had was with G6NF, making the fourth band with him!

W'9JGS: No blank days for dx since last fall, on those I was on the air. Received reports as high as R9, with many of R7 or better, from Europeans and others. Using 1000 volts on an 852.

W'6JLU: The gradual change in conditions continues. In October, the East coast signals started at 11:00 a.m., p.s.t., and continued until noon before starting to fade. The Europeans and North Africans came through about 8:10 a.m. lasting until about 9:00 a.m. But month by month the hours of reception seem to get later, and also to stay in a longer period of time. No doubt it is a seasonal effect. The last North African worked here was FA8BG; his signals reached a peak at about 11:00 a.m., R7 to R8. VK3YP and myself have QSO'd from the early evening right through until 8:30 p.m., while J8AB was still R9 on both continents. Many of the fellows have called J8AB but failed to raise him. The only station that has worked him is W7AMX, who thinks he is a phoney. The J8 amateur calls all start at J8C (since then, J8AA has been assigned). Undoubtedly he's in the Orient, because of Japanese rebroadcasts. The South Americans are once more coming into their own. Their signals are getting louder every day. Some favorites right now are LU9AX, OA4B, HJ3AJH, CP1AC. The VK and ZL stations come through as of old.

W'6VB: For the month preceding February 20, Europeans have been coming through intermittently around 8 a.m., with EA4AO heard at R7. South Americans are good at the same time. VK and J stations come through around 2:00 to 4:30 p.m. ZS2A is also heard. Am using a 6A6 Jones exciter, RK20 buffer doubler, and an HK354 final with 600 watts input.

VK3YP: Worked HJ3AJH for W.A.C. at both ends.
ZS1H: Worked VU2BL for W.B.E. and the first ZS-VU QSO on "ten".

Antennas

Up to a month ago, W2DTB used a 66 foot single wire fed Hertz which, he thought, was not good for Europe. He says, "Evidently this antenna operated on a harmonic is rather directional, even more so than one would suspect from a simple study of the field pattern. This might indicate that there is a lowering of the angle of maximum radiation in the direction of maximum field strength. The antenna was cut in half, and as predicted a decided increase was noted in Europe and Argentina. The antenna points in the general direction of Cape Town; so of course no improvements should be noticed from ZS1H, and reports from him bear this out."

W9GFD is using a six-element fixed beam with two driven antennas, two reflectors, and two directors. It can be reversed by changing the wires on the wood frame. When signals are weak using his pair of 210's on a long antenna, the beam rises the signal strength 3 "R" points.

W9FM tried a reversible beam using a driven antenna 8% shorter than a half wavelength, with two wires 3/8 wavelength ahead of and behind the antenna, each 13% less than a half wavelength long. An additional piece of wire 10% of a half wavelength was clipped to one or the other of these to make it a reflector. The 3/8 wave separation for the reflector was found to be satisfactory. Gain could be improved by adding a similar "bay" a half wavelength to the side, driving both antennas as does W9GFD.

W9JGS has continued his comparisons between a 66 foot horizontal and a 16 1/2 foot vertical, the latter backed by a reflector to the north. In all instances it has been found that for transmitting, the "vertical-and-reflector" arrangement is best in all directions except in the north quarter, including Europe. That one continent receives louder signals from the horizontal wire. Good signals are also put into South America with the horizontal antenna. For receiving, the vertical antenna and reflector give better signals except for Europe, when the horizontal is best; but again the reflector is working against Europe. West coast signals, off the side of both systems, sometimes are weak and fading on the horizontal wire, louder and steady on the vertical.

Receivers

Almost anything is being used as a receiver, some having trouble with high noise level in



even the better supers. W9NJZ has to run the gain all the way up to hear even W6's. We wonder how bad such receivers are on 14 mc.—something to look into!

Bill Schofield, W2DTB, has replaced his first detector with a metal 6L7, which noticeably reduces the hiss. He has successfully added a noise suppressor which reduces ignition interference.

On January 28, W3AIR rebroadcasted W3CGU and VK3YP to each other to enable them to QSO, this attempt being successful. Now VK3YP wants to work LU9AX that way to break down a difficult barrier!

Jerry Gorman, W6JJU, says that the short-haul men on phone and c.w., particularly for crosstown traffic clearing, are missing a marvelous bet when they pass up the 10 meter evening possibilities.

56 Megacycles

Herb Wareing, W9NY, writes that a local—he believes it was W9UMP—heard a W1 on five meter phone at about 5:20 p.m., January 19. The receiver was only a one-tube regenerator. W9NY is on 56 mc. crystal-controlled c.w. (code) at the time, but had received no dx reports when this was written.

W6VB is listening Sundays for dx, and expects to put a few hundred watts of c.w. on "5" soon. The way the police on 40.1 mc. have been reported between Illinois and California, some success should be had.

At W3SI, no 56 mc. dx was heard during January, and harmonics were heard only on one day.



Metal Tubes Cause Panic (in 1923!)

Two of the first metal radio transmitting tubes developed by General Electric Company were suspiciously regarded as bombs by the officials at the Panama Canal 13 years ago, and were kept under close watch in the ammunition "dump" there for fear that they were intended to blow up the canal locks.

This incident was revealed by I. R. Weir of the General Electric radio engineering department telling of experiences he had while installing a radio transmitter in Tegucigalpa, capital of Honduras, Central America.

"Upon arriving at the Panama canal, on my way to Honduras, I was surprised to find that I was detailed for special investigation after the regular custom officials had made their inspection," Mr. Weir said. "It took some time for me to find out that I was suspected of carrying

bombs, probably with the intention of blowing up the canal locks. After much argument and explanation it was agreed with the canal officials that I should leave my radio vacuum tubes in the ammunition dump during my stay in the canal zone."

One of Mr. Weir's greatest handicaps in doing the actual installation work at Tegucigalpa was the lack of a technical vocabulary among the natives, he said.

"First I attempted to teach them the English words for the various parts of a large tuning coil for the radio transmitter, but I found this very difficult. So I decided to ask them what each object suggested to them in Spanish. The large tuning coil suggested a sugar mill, the large porcelain insulators suggested sausages, the insulators used to support the wire were called guitars, the tuning coil wire was called a tube of many copper wires, and large rheostats were called victrolas.

"After realizing that these suggested words meant more to the native laborers than the correct terms, very little trouble was experienced in building the sugar mill with the guitars mounted upon sausages wound with a tube of many copper wires," Weir said.

Asked if there were revolutions in Central America while he was installing the radio transmitter, Mr. Weir remembered one in which 5,000 natives captured the capitol and cut all the telegraph wires between the radio station and the city.

"They thought in doing this they had cut off all our communication with the outside world," he said. "One of the radio operators in the city converted his regenerative receiver into a transmitter which was used to send all news of the revolution from the city to the radio station outside the city. There the news was relayed by the powerful radio station to the outside world. This mystified the revolutionists. I doubt if the native population ever did realize how the news of the revolution leaked out of the country."



Several amateurs have written in wanting to know why a 300 ohm line for the Collins multi-band antenna cannot be constructed from wire instead of tubing. The reason is that the wire would have to be spaced so closely together that it would be difficult to keep it separated. Spacing of about 1 inch would be required, and it would be hard to maintain that spacing when the feeder swayed in the wind.



A Relay Rack at Low Cost

By D. REGINALD TIBBETTS,* W6ITH

Many amateurs often long to have all their equipment built up in units and mounted in a standard relay rack. The chief drawback is

the securing of the rack. Commercial racks are priced beyond the reach of most amateurs and a lighter and less rigid rack, although less expensive, is less desirable. There is no reason why any amateur cannot build his own rack, standard in every detail, at a very low cost and in his own workshop.

Rack and panel construction is a practice borrowed from a long established telephone practice. It offers many mechanical advantages, facilitates service and inspection, and lends itself to the increasing association of radio apparatus with telephone equipment, besides enhancing the appearance of the apparatus.

There is a very noticeable trend in amateur as well as in broadcast and communications installations to eliminate the hay-wire impression which has characterized radio equipment in the past. This newer atmosphere not only contributes directly to the efficiency of the station, but inspires a vital confidence in the minds of non-technical visitors. For amateurs to keep well up in the public mind and opinion, their stations must not have a junky, hay-wire appearance.

The relay rack type of construction offers many advantages not to be found in other styles. Its appearance is commercial, parts are quite accessible, and alterations which change the physical size of one section of the transmitter can be made without requiring corresponding alterations in other sections, as would be the case with a frame-mounted or four-poster transmitter. The reason for this is that each section of the transmitter is provided with its own mounting unit, quickly removable after disconnecting supply wires. All the apparatus of the unit is supported by the panel.

The standard relay rack has two uprights made from three inch 4.1 pound channel iron.

How many times have you looked admiringly at a relay-rack transmitter and wished you had one in which to mount your own transmitter? Commercially, a finished rack of standard size costs as much as the parts for a medium power transmitter; but by following the instructions in this article you can build yourself such a rack for about \$10 (exclusive of panels). Nothing particularly difficult about it: just takes a little time and elbow grease.

The base is made from two pieces of 6 inch by 4 inch, $\frac{3}{8}$ " angle, and the top straps are made from two pieces of $\frac{1}{4}$ " by 2" cold-rolled

iron. The diagram gives all the details as well as dimensions necessary.

Panels are usually of metal (either steel, dural or aluminum) though sometimes made from pressed wood products such as "Tempered Masonite." Masonite is the cheapest, with steel, aluminum and dural next in order. The usual thickness of the metal panels is $\frac{3}{16}$ ", and sometimes $\frac{1}{4}$ " is used. Metal panels of thinner dimensions are not satisfactory. If Masonite is used only the $\frac{1}{4}$ " stock should be used. Most of the communication companies use the metal in the $\frac{1}{4}$ " thickness.

The versatility of the relay rack is due to the fact that dimensions have been completely standardized. A few manufacturers still use their own pet dimensions but they are quickly falling into line. Panels are 19" wide and of varying heights. The height is measured as a "rack unit," a rack unit being $1\frac{3}{4}$ inches. To allow for stacking and slight tolerance in cutting and fabrication, a relay-rack panel is always made to be a certain number of rack units high less $\frac{1}{32}$ inch for clearance. This formula can be used:

$$\text{panel} = n(1\frac{3}{4}) - \frac{1}{32}$$

Thus a panel four rack-units in height will measure 4 times $1\frac{3}{4}$ inches or 7 inches, less $\frac{1}{32}$ inch, or an exact total height of $6\frac{31}{32}$ inches. The channel uprights are drilled to take 10-32 round head machine screws as can be noted in the drawing. A very light tapped thread is sufficient, the usual 75% tap being unnecessary. Most of the strain on the thread is at right angles to the axis, and since this is shear on the screw, very little thrust is placed on the threads. A light thread takes less time and effort and results in fewer broken taps. When panels are properly made, the edge of a panel always falls midway between two holes spaced one-half inch apart.

*165 Perdue Ave., Berkeley, Calif.

RELAY-RACK PANELS

1. Make panel height a multiple of $1\frac{3}{4}$ inches less $1/32$ inch for clearances.

2. Both top and bottom edges of a properly mounted panel will, neglecting clearances, always fall half way between a pair of holes spaced $\frac{1}{2}$ inch apart on the rack.

3. It is seldom necessary to cut all the possible mounting-screw slots in a panel, but it can be done if desired.

4. Any panel laid out to fit the rack will also fit if the panel is turned end-for-end or back-for-front.

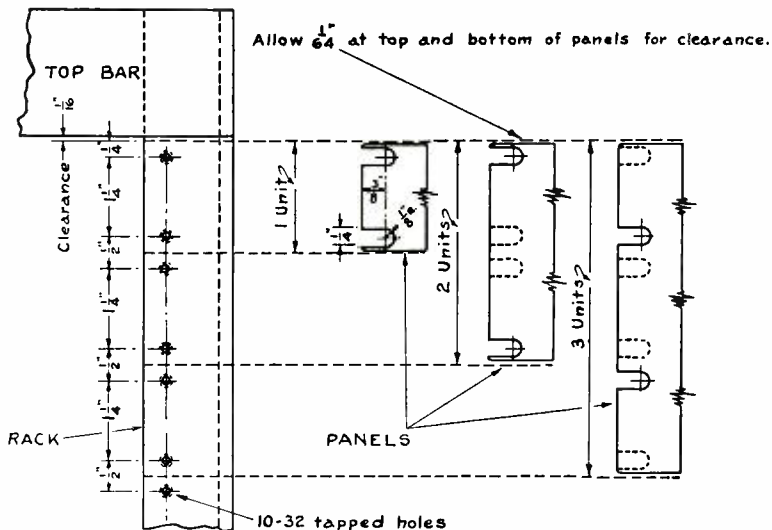

Note: Clearance between vertical supports on rack $1\frac{1}{2}$ inches.

Now to start your rack, go to the local steel company and order the following:

- 2 pieces 3 inch, 4.1 pound channel, $5' 9\frac{1}{8}"$ long
- 2 pieces 6 inch by 4 inch by $\frac{3}{8}$ angle, $1' 8\frac{1}{2}"$ long
- 2 pieces $\frac{1}{4}$ inch by 2 inch cold rolled, $1' 8\frac{1}{2}"$ long

The total price on the above steel order including the cutting should be around \$5.00. Make sure that the steel is cut square and exactly to the above lengths. It is just as easy for the steel man to cut the right length and your rack will come out square and save you lots of tough filing. Ordinary strap iron could have been used for the top straps, but the edges of this type of steel are not square and since this is such a small item, it is better to get the cold rolled for its square corners and finished appearance.

The steel will weigh within a pound or two of one hundred pounds. The next thing to do is to lay out the channels as shown in the drawing. Wipe off the steel and then chalk the front face of each channel. Use ordinary black-board chalk. Remember that one member is left-handed and the other right-handed; *don't* make two right or left-handed members. Two tools are now needed: a center punch and one of the dime-store steel pushrules. Don't under any circumstances lay out the rack with an ordinary foot rule or yardstick. The cumulative error will show up and the rack will not be square. Note that the line of the holes is in

$1\frac{1}{16}$ inch from the edge of the channel. Take a sharp pointed instrument and, using a scale set in a dividing head, mark this line (which will be the vertical line to the holes) carefully on the total length of the channel.

It can be seen that the top hole on each channel is $5/16$ inch below the top strap, or a total of $2\frac{5}{16}$ inches below the top of the rack. Carefully mark this top hole on each channel, keeping in mind that there is a right and left hand member. Now take the steel tape and clamp it to the channel with an even half inch or inch mark exactly opposite the hole that has been center-punched $2\frac{5}{16}$ inches from the top. This first hole is the reference mark and all measurements are made from this point. Now that the scale is clamped, go right down, first $1\frac{1}{4}$ inches and then one-half inch, alternating until 72 holes have been punched. If you have not made a mistake the last hole will be exactly $4\frac{5}{16}$ inches from the bottom end of the channel. While punching the holes, check back frequently. It is very easy to make an incorrect reading on the scale and a single "off hole" will throw all the rest in the wrong place. After all the holes are center-punched check back to see if the alternate $\frac{1}{2}$ inch and $1\frac{1}{4}$ inch spacings are correct. You cannot be too careful, as it is very easy to make a mistake here.

Now that all the holes are center-punched, do the same on the back if desired. The frequent spacings are not necessary, but a few holes may prove handy. In any case two holes

DIMENSION TOLERANCES	
FRACTIONAL	+ .010"
DECIMAL	+ .002"
UNLESS OTHERWISE SPECIFIED	

2 strips $\frac{1}{4}$ " thick
of top
Cold Rolled Steel

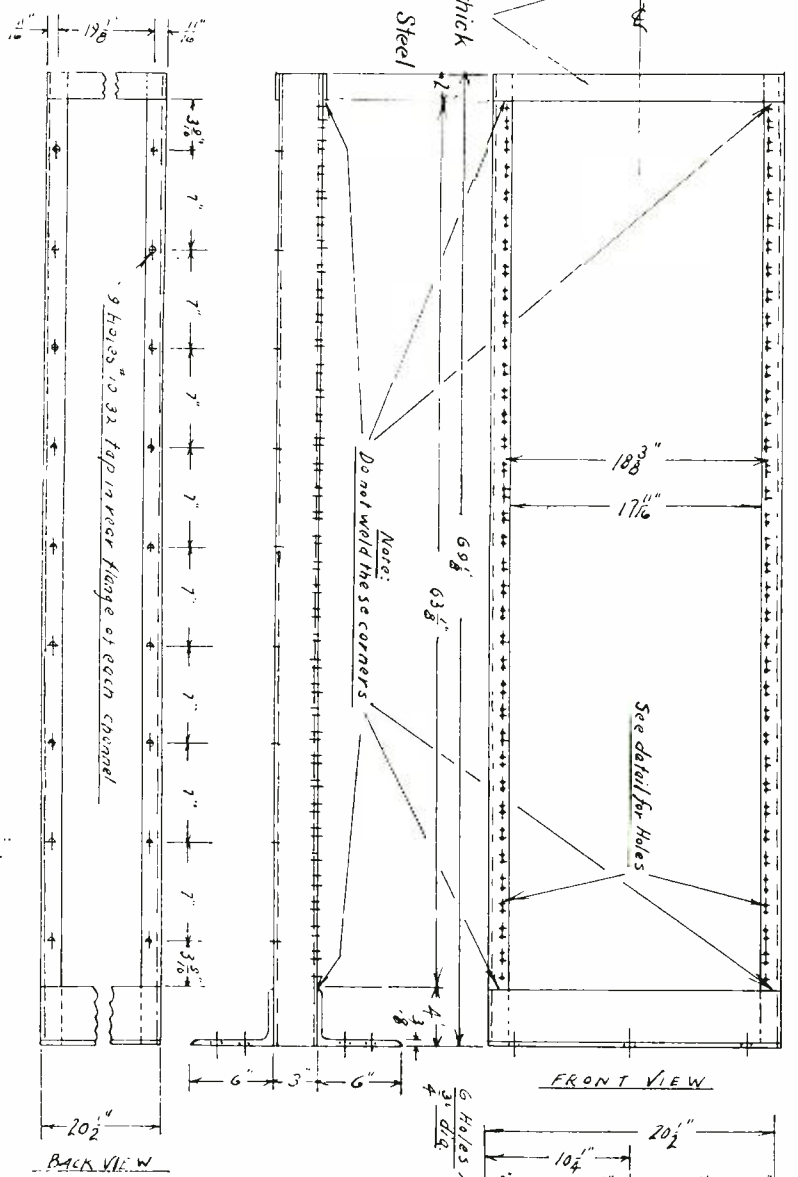

FRONT VIEW

BACK VIEW

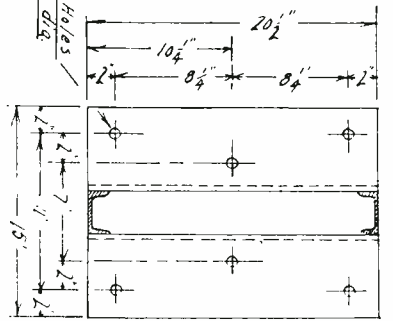

Detail of holes $\frac{1}{8}$ " scale.
72 holes in each Channel.
#1032 top. Space $1\frac{1}{2}$ " & $\frac{1}{2}$ "
alternately, leaving $\frac{5}{16}$ "
at each end as shown.

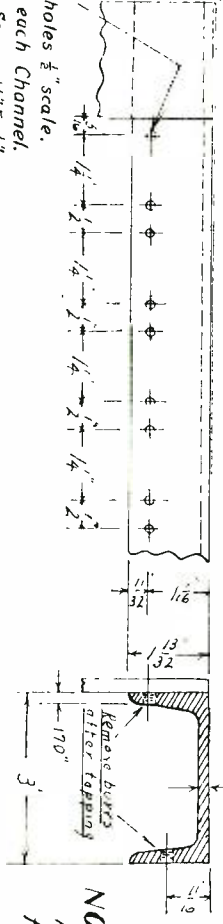

NOTE

Angles, channels, and straps: Gas-welded together. Do not weld corners designated.

Make of Steel

Scale: $\frac{1}{8}$ Size

STANDARD RELAY RACK

DATE: 9-21-35 DR C-T-S TR C-T-S CH. D.C.P

DWG. NO. 101



should be drilled and tapped about 5 inches above the bottom so that grounding and bonding wires can be fastened.

The next operation is to pilot-drill all the center-punches. It is suggested that a small drill, number 28 or so, be used for this purpose. This operation consists of drilling the punch marks slightly so as to preserve the spacing and to give the tap drill a good bearing surface. The pilot holes need be drilled only until the maximum diameter of the drill is reached, which is about 1/16 inch deep.

After all the pilot holes are drilled, select the tap drill that will give the correct percentage of thread desired. For 10-32 thread of 75% clearance thread, a number 19 drill is correct. However, 75% thread is really unnecessary and several sizes larger can easily be used as explained before. The author has built over fifty racks and for a drill press used a small mail-order house type which, with motor, cost about \$20.00. A good, high speed drill and a little oil make the drilling operation quite simple. Remember to set the channel so as to get the holes at right angles to the channel axis.

After all the holes are drilled, tapping is next in order. Use a small hand tap-wrench, and above all things remember to get a *taper tap*. This type of tap is tapered and will easily go through without very much effort. Use plenty of thread cutting oil and take it easy. If you feel that you are getting tired, stop and come back to the job later. Don't look out the window at passing y.l.'s when tapping; the least side twist on the wrench will break the tap.

When all the tapping is done, clean the burrs off the holes on the inside of the channel. This can easily be done with the head of a file.

The only other holes required are the base holes in the bottom angles. These are desirable, but not necessary. The racks are self-supporting with most amateur radio equipment and do not need to be bolted to the floor. However, if it is felt the bottom holes are desirable, have some machine shop drill or punch the holes. The job is too tough for a small drill press.

The next operation is welding. This is a difficult job and can best be done by an experienced welder. Take the pieces to him together with the drawing and show him just where the welding is to be done. There are eight welds altogether, and make sure that the welding is *not done where the panels will mount*. The rack should be set-up on a weld-

ing table and checked several times for squareness. Before the welding "tacks" are made, check again the distance from the center of the bottom and top holes to the strap and the base. This must be exactly 5/16 inch. If it is less the panels will jam, and if it is more, an open space will show through. A welder should not charge over \$4.00 for this welding job. Make the welder keep in mind that you want a "finished" job; it won't cost you any more provided you get him to set the price first!

After welding, the steel should be well cleaned and given a good coat of paint. Black is usually used, although black panels set against a rack painted with aluminum lacquer is quite striking.

WITH, the author's station, is built entirely on nine racks. The first was built a good many years ago, and, as expansion has taken place, more racks have been added. The rack dimensions given are for a standard rack giving a total mounting space of 36 racks units, the total height being 69 1/8 inches. If a shorter or taller rack is desired, it just requires a little calculation on the upright channels.

In case you do not wish to do the work yourself, take the drawing to a steel man and get his price. The drawing is a typical shop plan that can be turned over to any good craftsman without further instruction. However, you will find the greatest cost is the labor involved in the drilling and tapping of the holes, and this had better be done yourself in your spare time unless price is not an item.

◆
The Greater St. Louis Amateur Club, membership over 200, has earned great respect and appreciation from the parts manufacturers by purchasing their prizes instead of attempting to "chisle" them. As a result, they have the whole-hearted cooperation of the manufacturers when they want speakers for special gatherings, and consequently are able to schedule some really worthwhile technical talks.

◆
We wish to announce that our engineers have developed in our laboratories a noise-silencer for the Wilson "Puckering Tooka". However, as we wish to give credit where credit is due, we must state that the idea of our silencer was not original with us; it was adapted from a system invented by Professor Ople Soss. Contrary to the policy of some of our contemporaries, we are going to wait until we have chased all the bugs from the circuit before showing it in RADIO.



A Multiband Single-Wire-Fed Antenna

By FRANK C. JONES

The single-wire-fed antenna has long been considered an all band antenna without giving it much thought. A

little study of the usual design will show that it is really only good on one band and quite inefficient for harmonic operation on other higher frequency bands. However, a small compromise in efficiency on the fundamental

The old dodge of working a "cut by chart" single-wire-fed antenna on harmonics for all-band-operation seems to be "all wet". The commonly accepted assumption that such operation is perfectly all right caused Frank Jones to scratch his head, get out his slide rule. When he finished his calculations and then slid the feeder tap around without regard for accepted practice, a new, highly efficient all-band antenna was the result.

A feeder tap at $18\frac{3}{4}$ feet would place the tap about $15\frac{1}{4}$ feet from a node for 40 meter operation and about $1\frac{3}{4}$ feet for

20 meters. This is nearly double the correct value for 40 meters, as it should be about $9\frac{1}{3}$ feet; and less than half as far as it should be on 20. This means that the antenna and feeder would tend to work against ground as a T antenna on 40 meters with extreme radiation from the feeder. On 20 meters unless the feeder happened to be a certain length, very little power could be absorbed from the final amplifier effectively.

The same holds true of a 66, or 67 foot antenna for fundamental operation on 40 and harmonic operation on 20 and 10 meters. The magical distance of $9'4"$ would be fine for 40 meters but extremely bad for 20 and 10 meters, being $7\frac{2}{3}$ feet and less than $\frac{7}{8}$ foot from nodes respectively.

By increasing the distance out from center to approximately $\frac{1}{6}$ instead of $\frac{1}{7}$ of the antenna length, a very good compromise is obtained for all-band operation. In the case of the 136 foot antenna this would give 22 feet from the voltage node (lowest impedance point) on 80 meters, 12 feet on 40 meters, and 5 feet on 20 meters. These values will more nearly match the impedance of the single wire feeder and also allow greater ease of coupling the feeder to the final amplifier for power transfer. For a 67 foot, (or 66 foot) 40 meter antenna, the feeder should be connected 11 feet off center if operation on 20 and 10 meters is desired. This gives a distance from nodes of 6 feet and $2\frac{1}{2}$ feet for 20 and 10 meters, values reasonably close to the proper impedance.

In order to make the feeder non-reactive at the station end, it can be made some multiple of a quarter wave long either in actual length or by means of a tapped loading coil. Generally it can be draped around clear of buildings so that it will be nearly some multiple of quar-

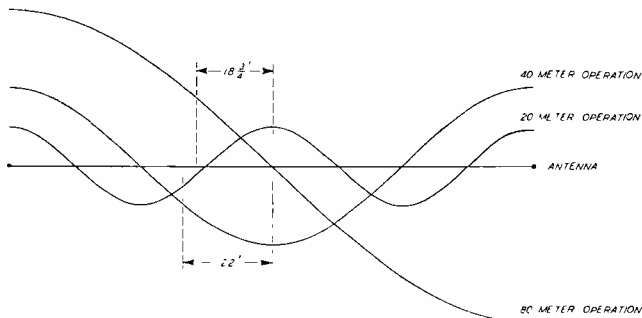

Figure 1

will make the antenna equally efficient on all higher frequency bands—and by special feeder design very little if any sacrifice will be made.

A typical 80 meter antenna is 136 feet long for c.w. operation. According to one commonly-used design chart, the single-wire feeder should be tapped $18\frac{3}{4}$ feet off center in order to match impedances and prevent feeder radiation. This magical distance would of course be changed somewhat by the antenna surroundings. A study of figure 1 will show that this distance is, in proportion, wrong for harmonic use and great mismatch and feeder loss would take place as well as excessive feeder radiation. About half of the power would be lost before getting it into the antenna flat top.

The curves shown in figure 1 show the approximate voltage distribution along the antenna for 80, 40 and 20 meter operation assuming correct feeder connection. The antenna is a half wave long on 80, one wave long on 40, and two wavelengths long on 20. For 10 meter operation it would be four wavelengths long with considerable endwise directivity.

ter wavelengths long, such as 33, 66, 99 or 132 feet long for a 40-20-10 meter antenna. By doing this, the reactive effect can be minimized, making the feeder system extremely efficient in spite of a small impedance mismatch at the antenna.

The antenna length should be cut so that it is correct for the highest frequency band desired. Its length will be a few percent long for the lower frequencies, but the error will be proportionately smaller than if designed for the lowest frequency. This whole discussion applies to the design of a multiband antenna, which necessarily means some compromise. The reason for this discrepancy in length is due to the end effects which shorten the ends about 2½% each. As can be readily seen, this shortens a half wave antenna 5%, but not that much for a one or two wavelength antenna. Only the free ends are shortened 2½%. The design formula is:

$$L = \frac{(k - .05) (492,000)}{f_1}$$

where L is the length in feet, f_1 is the frequency in kc., and k is the number of half wavelengths. The factor f_1 should be the highest frequency used. Turning this formula around, the exact crystal frequency can be determined for best operation in each band, though one crystal frequency and its harmonics are normally used.

The feeder length can be calculated exactly for a station end pure resistive impedance from the formula:

$$l = \frac{234,000}{f_2}$$

where l is in feet and f_2 is the lowest frequency desired. The feeder length doesn't need to be exact, and satisfactory results can be obtained with any length.

A typical 40 meter antenna 67 feet long would operate best near 7000 kc., 14,300 kc., and 29,000 kc., which would require three different crystals. A suitable compromise in this case would be a 7100 kc. crystal with its harmonics of 14,200 and 28,400 kc.

In order to receive or transmit in nearly all directions, two antennas should be available, at right angles to each other. As a rough approximation, one running north and south, and the other east and west would be suitable for amateurs living in the United States. A single-pole double-throw switch would connect either one

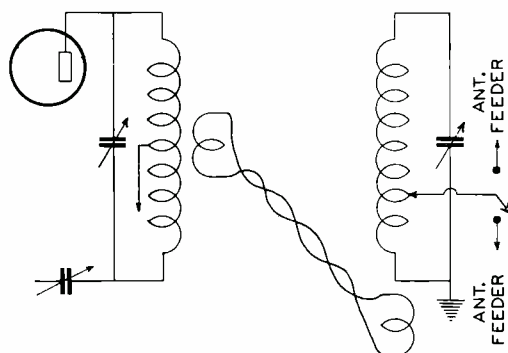

Figure 2

to the transmitter. The most desirable method of connection to the transmitter would be that of figure 2, where the feeder taps onto the antenna coil from 1/5 to 1/3 of the way up from the grounded end. Two link coupling turns at each end of the link circuit should provide sufficient coupling for moderate C to L ratio of tuned circuits. The advantage of this scheme over a direct tap on the final plate coil is isolation from d.c. plate potential, no unbalance of the final push-pull or neutralizing circuits, and great reduction of undesired harmonic radiation.

◆
If you have trouble with pie-wound r.f. chokes collapsing, or if your tank condenser sparks over more than previously, check up on your plate blocking condensers; unless the condensers are rated at several times the plate voltage, they may break down with no other indication of trouble. To test them, just put them in series with the plate of a tube. If the tube draws current, the condenser is shorted. Putting a condenser across a power supply may cause damage if it really is blown.

◆
In a recent two-way experimental radio chat between HJ1ABB in South America and W2XAF in Schenectady, engineers learned why the Colombian station went off the air so abruptly a short time ago. A tame alligator emerged from the Magdalena River near the new one kilowatt Barranquilla transmitter, entered the building housing the unit, flipped its tail and broke one of the large radio tubes in the transmitter.

◆
G2YL is a young lady . . . W7EUA is named *Shirts*; W7PW, *Collar*; W8ARQ, *Vest*. . . . *Green, Black, White, Blue*, and *Dye* are the names of W8's. . . . *Hammer and Nail* are W6HWW and W6IIL.

The Noise Reduction Problem

By ROBERT S. KRUSE

Major Armstrong has taken down from the dusty shelf the old idea of frequency modulation and from it has made something which looks very much like a cure for static and other high-voltage-noise interference with broadcast reception.

One naturally begins to speculate as to the advisability of getting down from other dusty shelves that great tribe of devices which attempt to stop noises in an ordinary receiver which is tuned to an ordinary signal. By "ordinary signal" is meant one which is key or voice modulated in the ordinary way. This ordinary or amplitude modulation produces voltage-changes in the receiver; hence the receiver is made voltage-sensitive so as to permit it to make sense of the signal. That is where the noise comes in, for unfortunately, a voltage-conscious receiver is also very acutely aware of high-voltage noises such as static of the explosive sort, or other high-voltage abrupt impulses.

This circumstance has given rise to the tribe of devices already mentioned, and which date far back into the spark days of radio. The tribe has three families:

- A) Those devices which attempt to limit the response of the receiver, those which put a limit on the loudness of the noise which can be produced.
- B) Those which try to cause a noise to follow two channels which are finally turned toward each other so that the two sections of the noise meet head-on and destroy each other.
- C) Those which try to block the receiver more or less completely and thus stop it when a high-intensity noise comes along.

In each family there are members with whiskers six feet long.

A Commercial Limitation

The output-limiters are quite ancient. Most of them have been forgotten. It may amuse the present tube-using amateur to resurrect one crude scheme we used in the spark days. We cut the plate voltage of the last tube (or its filament) away down until the static no longer caused our eardrums to crack. If the static wasn't too bad and the signal was very strong one could still receive a little.

You will note that this Simple Simon noise-limiter required adjustment to meet the conditions. This seems to be the common failing of noise limiters as a family; the user of the set has to adjust them to suit the conditions and the toughness of his nerves and eardrums.

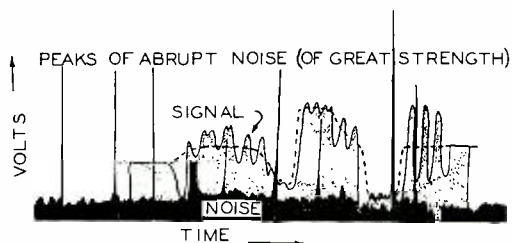

Figure 1

In the estimation of most commercial engineering departments an anti-noiser which requires such adjustment is a dangerous thing to put on the market. If the thing does not get properly adjusted by the user there will be a whale of a comeback from the dealers and eventually all such headaches come to the engineering department to roost. This is what makes engineers conservative.

Anyway, the noise limiters do not on the face of them show promise of getting the noise *below* the signal; they merely hope to cut it down to some level *not too much* above that of the signal. C.w. operators can receive through noises several times as loud as the signal though it has been observed that they gradually take to drink. Voice operators don't like noises to be that loud, and entertainment listeners just darn well will not put up with it and keep listening.

From an amateur standpoint, therefore, the noise limiters have pretty good promise. A very simple one has been worked out this past year and when the static season rolls around again it should be in shape to show to the readers of RADIO.

The second family of anti-noisers is exceedingly numerous. This is the "B" family which attempts to buck two noise-voltages against each other. Such bucking has been attempted at every point from antenna to loudspeaker. One ancient scheme, for instance, used two antennas with slightly different tuning, both coupled to a receiver. The signal was supposed



to arrive via one antenna, the noise via both antennas—thus bucking itself out. This worked partly—sometimes. When a real loud static splash arrived it did not work at all. This on the grand average has been the performance of all the buckers.

The popular horizontal doublet with twisted downlead for receiving shortwave broadcasts makes no attempt to erase static. It does help by avoiding pickup near the wiring of the house, and by gaining some advantage from its relative insensitivity to waves polarized as wire-system noises sometimes are. It is not a noise-bucker and falls down quite miserably under a static attack, and some other sorts of noise.

That the Armstrong system *does* manage to buck out noises is due to abandonment of the voltage-conscious receiver. The Armstrong receiver includes a response-limiter. After the signal and noise have gone through this device it becomes possible to do successful noise-bucking if the response-limiter is set far down so that its limit is reached by the signal. This low setting would murder an amplitude-modulated signal but Armstrong does not use such a signal. Thus, if you please, the Armstrong system consists of three "no good" ideas, to wit: frequency modulation, a response-limiter, and a noise-bucker of the double-detector variety as described in our January issue.

The Blockers

The "C" family consists of those devices which slam the door when a high-intensity noise arrives. After that it is supposed to open the door again quickly so that not too much signal will have gone by without entering.

The simplest example of such a device is the ancient Telefunken "static shunt" which consisted of a neon tube connected across the receiver input. When a hearty static splash arrived the tube broke down (ionized) and momentarily short-circuited the receiver, thus limiting the damage to ears. Older radio men will also remember that some sorts of "soft" or "gassy" detector tubes gave a similar effect without external aid, but usually failed to clear up until the plate voltage was taken off. By that time the operator had lost a word or two.

A less crude approach is that which is possible with a multi-tube receiver and depends on some variation of the automatic volume control idea. We have here two obvious possibilities. One is the familiar "quench," "squelch," or "quiet a.v.c." arrangement which assumes

that no signal is worth while below a certain level, hence shuts off the receiver whenever there is no carrier that strong. Naturally it also shuts off the noise. This "q.a.v.c." business is tolerably commercial because the manufacturer need not provide any panel adjustments for the customer to twiddle. He sometimes provides an adjustment at the back of the set where the customer generally overlooks it, or he may provide a switch or push-button so the customer can switch the "Q" in or out at will. Of course if the service man didn't guess right as to the local noise level when setting the behind-the-set control the customer may think the set too noisy or too insensitive. This "Q" business seems to have rather less bearing on amateur communication than some other devices.

Another approach is to use a high-speed automatic volume control so devised and adjusted that it is not actuated by signals but will be triggered off by short-duration impulses of great abruptness and of great amplitude. To give noise suppression without undue ruining of the received signal such a device must evidently be extremely fast in action.

The accompanying sketch is a purely fanciful representation of the general problem faced by this and other noise-reducers. The noise (black) consists of a general "hashy" background composed of many contributions of small size, plus the objectionable high-intensity pulses sprouting out of this base in the form of high peaks of short duration which, due to inertia of audio circuits and speaker cones, do so much damage. The elimination of these peaks is the problem. This problem alone would be simple. The difficulty is entirely to accomplish this while retaining the signal represented by the shaded area. This shaded area is supposed to represent a *fading* signal with modulation. The carrier level is wandering up and down due to fading, and following the route of the dashed line.

The Difficulties

Now any trigger-device, including the high-speed a.v.c. blockers just mentioned must either be able to wander up and down with the carrier, or else must be able to ignore anything and everything except a very abrupt impulse. To "wander" them up and down by hand is like trying to hold a signal constant with the hand volume control of a set having no a.v.c. Therefore the second possibility seems most attractive: to make the a.v.c. blocker ignore everything but very abrupt impulses and gamble that this would include most loud noises.



More Effective Automatic Gain Control

By FRANKLIN OFFNER,* W9FTO

Some time ago, we finally got sick of the hash our old receiver was pulling in on twenty meter

Here is an a.g.c. system that has them all licked. It really holds down an R99 signal to within a few db of an R7 signal. And all without sacrificing sensitivity on weak signals. It is a star performer on controlled-carrier signals, the Waterloo of most a.g.c. systems. It can even be used to advantage on c.w. when adjusted for such operation!

and noise level are concerned. So the question was, "Which line-up will provide the best a.g.c.?" not

phone; so we decided to see what we could do towards improving conditions on the receiving end. As anyone who has done much listening on this band knows, the requirements

forgetting, however, that simplicity, cost, and reliability all had to be considered.

Our next step was to examine all the a.g.c. circuits we could dig up, trying to find the most suitable. A theoretically perfect system of a.g.c. would act as follows: Beginning with a strong signal, as the signal level decreases, the sensitivity of the receiver should be increased proportionally, so that the output level of the receiver remains constant. As the signal level is still further decreased, a point will be reached where the signal begins to fade into the background. Beyond this point, there is no advantage to be gained from a further increase in sensitivity; and, indeed, such would be a disadvantage, as the noise level might build up to uncomfortable levels when a station goes into a deep fade, or when tuning between stations. Looking at the matter from the other end, when

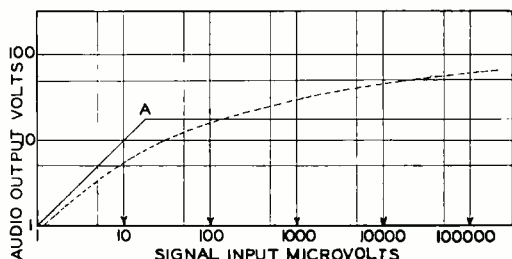

Figure 1

of a receiver are rather severe: the sensitivity must be high, the noise level low, the selectivity must be very good (what with stations piled knee deep!), and, if the greatest ease and pleasure are to be had in operation, an especially effective automatic gain control system must be provided. This last requirement arises, of course, from the prevalence of fading at twenty meters. These characteristics are all desirable on the lower frequency bands, but the tolerances are not quite so rigid.

After we had decided on these requirements, all that remained was to design and build a receiver living up to them! After considerable thought and inspection of numerous receiver circuit diagrams, two alternative line-ups were decided upon. The first was a stage of t.r.f., mixer and separate h.f. oscillator, two stages of intermediate frequency amplification, grid-bias detector, beat oscillator, and power audio. The second was the same, but with three stages of i.f., and diode detection. As pointed out in a previous article,¹ these two line-ups should be about equivalent, as far as sensitivity, selectivity,

tuning in a weak station, we wish to be able to set the sensitivity of the receiver at a suitable value (depending on the noise level at our location), and the sensitivity should not be decreased by the a.g.c. until the signal has

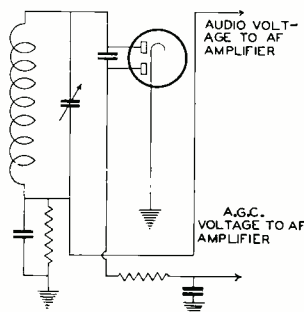

Figure 2

reached the level we wish. It should then hold the output constant for any further increase in signal level. The operation of such an a.g.c. system is illustrated by the solid curve in figure 1. It is seen that the output of the receiver is proportional to the signal level up to some point "a", beyond which the output remains constant. The action of the gain control is thus delayed until the signal reaches some predetermined level. Hence it is termed "delayed automatic gain (or volume) control," or "d.a.g.c."

*951 E. 58th St., Chicago, Ill.

¹Offner, "Grid Bias Detection," RADIO, Feb. 1936, p. 20.

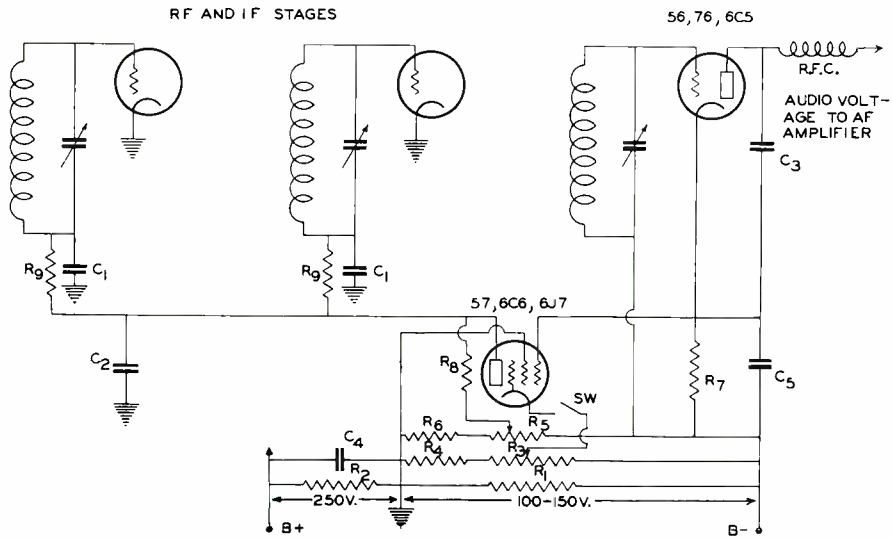

Figure 3

The Diode Method

The most commonly used system of a.g.c. is that employing diode detection. A popular form is shown in figure 2. Here, a duplex diode is used, one section being used for detection, and the other to supply the a.g.c. voltage. It is clear that the voltage available for a.g.c. will be directly proportional to the signal volts developed by the detector (assuming, of

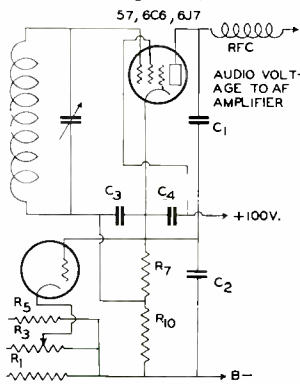

Figure 4

course, constant percentage of modulation). Thus, even a weak signal will cut the sensitivity of the receiver somewhat; and further, the control action on strong signals will never be especially good. The calculated characteristics for a typical diode a.g.c. circuit are given by the dotted curve of figure 1. It can be seen that the action is rather far from the ideal. The control action at higher signal levels could be improved, but only at the expense of lessened sensitivity for weak signals, and conversely.

The Biased Diode

In an attempt to get better results from diode a.g.c. systems, a circuit has frequently been used in which a negative bias is applied to the

gain control diode. In this way, d.a.g.c. action is obtained, as no diode current will flow until the signal voltage across the diode is greater than the fixed bias. The difficulty with this system is that with 100% effective control action, the r.f. peaks will be kept at a constant level, rather than the carrier. This will obviously result in a decrease of 50%, or 6 db, in signal amplitude at 100% modulation, as against zero percent. With less effective control, this defect is present to a smaller degree. It is furthermore difficult to secure really effective a.g.c. action with any diode system, unless a separate a.g.c. amplifier and diode rectifier are used.² However, the resultant complication will make this arrangement appeal to but few amateurs, especially if three intermediate amplifier stages have been already made necessary by the use of diode detection.

A.G.C. and Bias Detection

The desirability of combining a.g.c. with a grid-bias detector prompted the use of the system described for the original A.R.R.L. single-signal super.³ In this system the a.g.c. voltage was taken directly from the cathode resistor of a plate detector. This requires the use of a separate power supply for the second detector, and so again introduces undesirable complications. In addition, true delay action cannot be obtained with this system. [Cont. on Next Page]

²As, for example, in the receiver shown in the A.R.R.L. *Handbook*, p. 116 (1936 ed.).

³Lamb, "Automatic Gain Control for the Superhet," *QST*, Nov. 1933, p. 32.



The New System

A study of all these a.g.c. systems finally convinced us that none would be really satisfactory for our receiver. So we decided we would have to try a design of our own. The circuit that finally evolved has been in use in the author's receiver for the last eighteen months and has been so satisfactory that we believe some other amateurs might like to build receivers using the system.

The system consists fundamentally of two portions. The first is a device for generating a d.c. voltage that varies in accordance with the average carrier amplitude, and the second is a d.c. amplifier for this voltage, connected so that it only comes into operation when the carrier amplitude exceeds some predetermined level. As the average carrier amplitude is unchanged under symmetrical modulation, the defect noted above for the biased diode d.a.v.c. system won't enter here. The voltage output from the d.c. amplifier is, of course, applied to the control grids of the controlled stages. As we wished to use a grid bias detector in our receiver for reasons already given, the logical place to obtain the d.c. voltage varying with the carrier seemed to be from the cathode biasing resistor of the detector. The drop across this resistor is then amplified by the d.c. amplifier. Now as the amplifier tube inverts the phase of this voltage, the drop across a resistor in its plate circuit will provide control voltage of the proper phase without the use of a separate power supply. The d.c. amplifier tube is biased past cut-off by an amount equal to the drop in the detector cathode resistor at full signal output. This voltage is determined as described in the reference mentioned.¹ Then when a strong signal comes in, tending to increase the second detector plate current, and hence the drop in the cathode resistor, the bias on the d.c. amplifier will be reduced, current will flow in its plate circuit, and the voltage drop in its plate resistor furnishes a.g.c. bias for the receiver.

All this may sound a little complicated but it will probably be made a lot clearer by referring to the circuit diagram of figure 3, which illustrates a typical system employing these principles. Here a triode second detector is used, with a pentode d.c. amplifier. The voltage for the latter is shown obtained from a voltage divider (R_1 and R_2), but other arrangements, convenient in any particular receiver, will suggest themselves to the reader. The author has

found it convenient to use the field of a dynamic speaker at R_1 , thus killing two birds with one stone. The plate current of all stages but the detector and d.c. amplifier passes through R_1 . This was enough to make R_2 unnecessary. In any particular case, it may be necessary to use additional resistors in series or shunt with the field to obtain the required potential drop without exceeding the wattage rating of the field.

Choice of Constants

R_3 may be a resistor of the "semi-variable" type, about 10,000 ohms in value. R_4 would then be about 25,000 ohms. R_3 and R_4 could be composed of a single resistor, but its adjustment would then be a little more critical. Again, if a shunt resistor is required across R_1 , as described above, the sum of R_3 and R_4 may be made equal to the required resistance. Any number of other arrangements can be used, provided that sufficient range of adjustment is provided by R_3 , as described below. R_5 is the sensitivity control; it controls the bias of the r.f. tubes. It may be a 100,000 ohm potentiometer. R_6 prevents the bias from being lowered below some minimum value; about 3000 ohms would be right, but the exact value will depend upon individual receiver design. The cathode resistor, R_7 , is determined as in the reference (¹). The a.g.c. voltage is developed across R_8 , 100,000 ohms. R_9 and C_1 form the decoupling network for the grids; they are 100,000 ohms and 0.1 μfd , respectively. The time constant of the a.g.c. circuit is largely determined by R_9 , R_8 , and C_1 . It may be increased (as for c.w. reception) by the addition of more capacity at C_2 .

The detector can be coupled to the audio stages either through a transformer, or resistor and capacity. In any case, an audio gain control will be required, as the excellency of the a.g.c. action makes the r.f. gain control (R_5) practically ineffective for volume control when a.g.c. is in use. Opening the switch "sw" eliminates a.g.c. action.

In some cases where detectors using a low grid bias are used (for example the 57, 6C6, or 6J7), the variation in the drop across the cathode resistor may not be sufficient to give enough control voltage. In this event, another resistor should be used in series with the detector cathode, so that the total drop across this resistor and the bias resistor will be sufficient. This is illustrated in figure 4. R_{10} is the added resistor. The total drop across R_7 and R_{10} in general need not be over 20 volts.

Adjustment

The system is operated as follows: With the receiver warmed up, open the switch "sw", cutting out a.g.c., and tune in a fairly strong carrier. Set the r.f. gain control (R_5) so that the cathode current of the detector is somewhat more than the predetermined correct value. A meter in the cathode circuit will come in handy here. Now close "sw", and vary the slider on R_3 so that the cathode current of the detector is at just the desired value. Set the audio gain control so that the signal is at a comfortable level. Now tune off the carrier and set the r.f. gain to a point where the background noise just begins to come up. The receiver is now adjusted for optimum reception of any signal. On tuning from station to station, you'll notice that any signal much above the background noise will come in with just the same carrier strength, the audio volume depending on the percentage modulation. In addition, when tuning between stations, the background noise won't come up to objectionable levels. Tests with a standard signal generator indicated that the control action obtainable very closely approximates the theoretically perfect curve (solid curve, figure 1). The audio output level varied less than three db for inputs varying over 80 db, certainly enough for any practical purpose.

For C.W.

When a.g.c. action is not desired, "sw" is opened and the signal level is controlled by R_5 .

It should be noticed that this system is ideally suited for use in c.w. reception without the use of a separate a.g.c. rectifier. Say that R_3 is so set that the detector cathode current is kept at two milliamperes. Then the beat oscillator strength is set so that it will give a detector current just under this—say, 1.8 ma. Thus it will not actuate the a.g.c., leaving the receiver sensitivity at maximum, and full a.g.c. action will be obtained on any c.w. signal of sufficient amplitude to kick the detector current up the additional two-tenths milliampere.

Controlled Carrier

It has been found by experience that this a.g.c. system will give excellent results when used for the reception of 'phone stations using controlled carrier modulation.



File Lubricant

When filing aluminum, dural, etc., the file should be oiled or rubbed in chalk, but will cut slower than with no lubricant. However, the file will last much longer.—*W6DOB*.

Simplified Audio Design

The accompanying audio transformer design chart was submitted by Mr. I. A. Mitchell of the United Transformer Corporation with the comment: "I note that in recent issues of *R/9* attention was devoted in a number of places to the analysis of low frequency response of audio

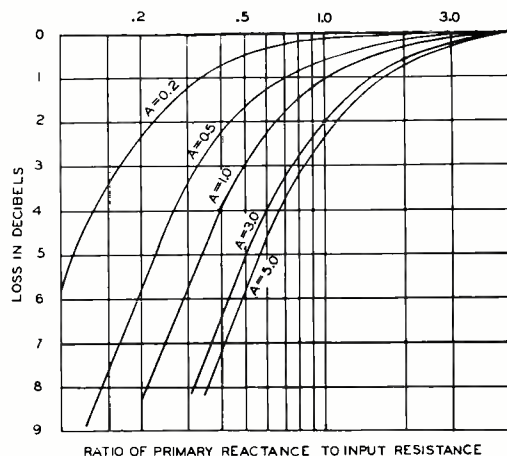

"A" is the effective load resistance divided by the input resistance.

transformers as respects the primary inductance. This phase of frequency response can readily be calculated theoretically, and I am attaching hereto a copy of one of the charts used by our design department for this purpose. I believe the information will be of service to your readers."

The 5 curves on the chart are seen to be labeled with various values of "A" from 0.2 to 5.0. This "A" is the effective load impedance divided by the input resistance.

"As an example of the use of these curves, let us assume a source and load (reflected) impedance of 500 ohms."

($500/500 = 1$, placing us on the curve "A=1")

"It is seen that at the frequency at which the primary reactance is 325 ohms, there will be a 2 db loss." ($325/500 = .65$, which lies on the top scale directly above the crossing of the curve "A=1" and the loss-line for 2 db.) "Consequently to design a transformer having a loss of 2 db at 40 cycles, the primary inductance would have to be such as to give an impedance of 325 ohms at 40 cycles, or an inductance of about 1.5 hy. Conversely the loss of a transformer at any frequency can be checked."

Putting the 35-T to Work

The new 35T looks to be somewhat similar to the 834 physically, with characteristics resembling the type 30B. The rated interelectrode capacities are slightly lower than anything on the market excepting acorn 955. This makes the tube particularly useful at the ultra high frequencies, and very respectable outputs can be obtained clear up to 250 megacycles. The advantages inherent in a low voltage, high current filament at the ultra high frequencies are not generally known. At 250 megacycles the filament in a transmitting tube is usually long enough to be a noticeable portion of a quarter wave in length. Thus, there usually is considerable inductance in the plate and grid r.f. returns to ground, which makes the tube unstable and inefficient as an oscillator and quite difficult to neutralize as an amplifier. In some tubes this effect is bothersome as low as 60 megacycles. The use of a short filament in the 35T materially reduces this effect and helps to increase the highest frequency at which the tube is useful. The μ and plate resistance are about the same as the 30B, which makes the tube easy to excite both class B and class C. A stranded plate lead has been avoided which cuts down the losses at the ultra high frequencies and the use of a Tantalum grid and plate prevents momentary overloads from damaging the tube. The 35T uses a Nonex envelope, which allows high heat dissipation through the rather small glass envelope. The elimination of the getter and metallic deposits from inside of the glass also improves the heat radiating ability of the glass and allows a smaller envelope to be used.

The physical dimensions are smaller than a standard 210 except for overall height, which is about the same as a 210. This allows very short grid and plate leads to be used.

The extremely close grid to filament spacing which made the 53 so popular as a crystal oscillator is a characteristic of the 35T. This feature allows high power output from a triode crystal oscillator to be obtained without excessive r.f. crystal current.

When the 35T is used as a class B modu-

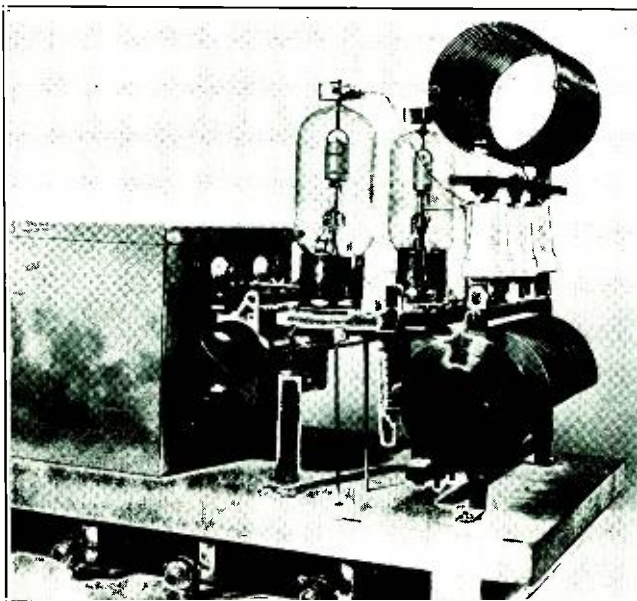

"Hopping up" a 210 transmitter with 35T's

lator it will run without grid bias at all plate voltages up to 650 volts. Above 650 volts enough bias should be used to keep the resting plate loss below the rating of 35 watts per tube.

The high μ (30) indicates that class B bias requirements will be low, and the high transconductance means that the d.c. grid current will also be low, which simplifies the bias problem.

When low level modulation (operation as a linear or grid bias modulated amplifier) is used the limitation of carrier output above 750 volts plate voltage is the maximum permissible plate loss of 35 watts per tube. Assuming 100% modulation capability, the maximum carrier power output for one 35T will be between 10 and 20 watts, using low level modulation. When used as a crystal oscillator, extreme care should be used to keep the oscillator heavily loaded when plate voltages in excess of 650 volts are used.

Practical Operation

The 210's were taken out of the final stage of the transmitter described by Martin Brown in the January and March issues, and replaced with a pair of 35T's to see how they would perform. It was found necessary to adjust the



plates of the neutralizing condensers till the plates were nearly all the way out before neutralization was accomplished. The fixed bias was dropped from 90 to 45 volts, and the grid leak left at 2500 ohms. Cranking the plate voltage up to 1200 volts gave quite a husky output when the tubes were loaded up to 200 ma. This was about as high as the voltage could be raised without the tank condenser flashing over. When modulated, it was necessary to drop the plate voltage to about 900 to keep the condenser from flashing, but even that voltage represented 180 watts input at 200 ma., nearly twice the input used on the original transmitter.

No changes were made in the physical layout when the tubes were tried in the transmitter, but it is unnecessary to mount the 35T's "up in the sky" like the 10's because the plate lead on the 35T comes out the top of the envelope. In fact, the leads could actually be made shorter if the 35T's were lowered a bit. Neutralizing condensers with lower minimum and maximum capacity would be advisable. These are the only changes advisable or necessary, other than provision for a 5 volt filament supply. The grid leak on the final stage could be reduced to about 1500 ohms, but little difference in operation will be noted. Lowering the bias will make it necessary to clip down on the buffer coil with the excitation clips to keep excessive plate current from being drawn on the buffer. The 10 buffer could also be replaced with a 35T, with an increase in grid drive to the final stage. But the 35T's in the final stage seem to get along fine on the excitation provided by the type 10, and it is doubtful if the substitution of a 35T for the 10 in the buffer stage would be justified.

CHARACTERISTICS

Filament Voltage.....	5 Volts
Filament Current.....	4 Amperes
Amplification Factor.....	30
Normal Maximum Plate Loss.....	35 Watts
Normal Maximum Plate Current (Average d.c.).....	100 milliamperes
Grid-filament Capacitance.....	2.5 μ fds.
Grid-plate Capacitance.....	2. μ fds.
Plate-filament Capacitance.....	0.3 μ fds.
Envelope.....	T14 Nonex
Overall Height.....	5 1/2 inches
Maximum Diameter.....	1 3/4 inches
Plate Voltage.....	200-1500 volts
Normal Maximum Grid Current (Average d.c.).....	20 milliamperes
Base (Isolantite insulation).....	UX 4 pin.

PERFORMANCE

Plate Voltage	Class B Audio Output (Two tubes)	Class C Output 75% eff. (Single tube)
500 volts	60 watts	38 watts
750	80	56
1000	115	75
1250	135	94
1500	150	112

OPEN FORUM

Wheeling, West Va.

Sirs:

Question: "What is your QRA, o.m.?" Answer: "W8BOW." This sounds silly; but it really isn't. Look up the international "Q sigs".

However, the question: "What is your QRF?" or just, "QRF?" would be answered: "Wheeling, West Va." Look this up too if you are skeptical. Where am I from? Naturally I'm from somewhere; at least my signals are! Aren't they going to the station I'm working? Then they must certainly come from someplace.

Why change now that QRA has come to generally mean "address"? Well, QRF sounds to me more logical. Anyhow, it has the advantage of being correct. If you don't want to change from QRA, why not change the definition of QRA? That's something that can be changed at the next International confab, when we get all those new kilocycles.

WILLIAM W. MCLAIN, W8BOW.

To Protect Brass from Tarnish

Thoroughly cleanse and remove the last trace of grease, by the use of potash and water. The brass must be carefully rinsed with water and dried; but in doing it, care must be taken not to handle any portion with the bare hands nor anything else that is greasy. The preservative varnish is made by mixing two parts of shellac to nine parts of alcohol. Put on with a brush as thin and smooth as possible.—W'6DOB.

Nature, beating radio engineers by a few hundred thousand years, has provided the human ear with automatic volume control, the body with temperature control, and "seeing equipment" which is a highly compact television system.

The radio alarm used on ships is something of a radio safe combination in that it causes a bell signal to sound only after the proper sequence of signals has been transmitted from the signalling station.

R.F. Interstage Coupling Methods

By J. N. A. HAWKINS, W6AAR

There are three principal methods of transferring energy from one amplifier stage to the next in a high frequency transmitter. The position of a coupler is shown in figure 1. First is capacity coupling, which is similar to what is termed impedance or autotransformer coupling in audio work. Second, there is in-

For many years there has been considerable discussion in amateur circles regarding the relative merits of capacitive, inductive, and link coupling between stages. It was felt that a brief outline of some of the advantages and disadvantages of each coupling method would be desirable.

ever, no errors of fact will result as long as we agree on the assumption.

The term *load resistance* is glibly discussed in all amateur discussions covering class B or class C amplifier operation. It is well known that for any given set of operating conditions of a vacuum tube, (plate voltage, bias, excita-

Load Resistance

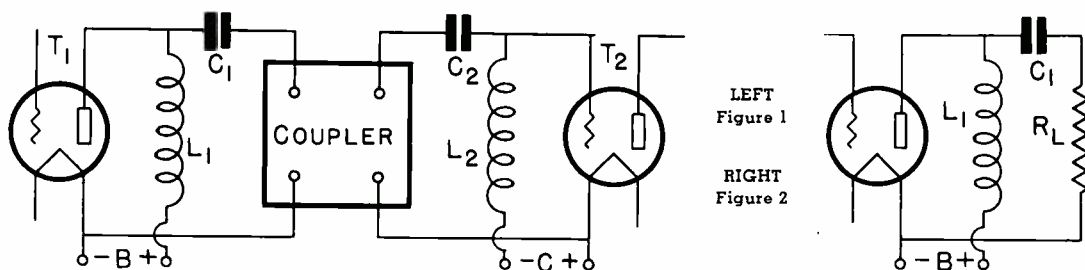

LEFT
Figure 1

RIGHT
Figure 2

ductive coupling, which corresponds to transformer coupling in audio amplifiers. And third, there is link coupling, which is merely a special form of inductive coupling which uses a low impedance transmission line to serve as the coupling medium between two resonant tank circuits.

Before outlining the fundamental factors governing each type of coupling the author and the reader must agree on certain assumptions or practices and definition of terms.

The term *driver stage* will always refer to the r.f. stage supplying power to our coupling device under consideration. The term *driven stage* will refer to the amplifier stage receiving power from the coupling device. Thus our coupling device takes power from the plate circuit of our *driver stage* and delivers it to the grid circuit of our *driven stage*.

In order to avoid using the often misunderstood term *impedance* we will make the assumption that all tank circuits will be tuned to resonance, at which time all *complex impedances* magically turn into simple *resistances* which obey Ohm's law and whose effect on the circuit may be mentally visualized in terms of familiar d.c. phenomena. Therefore, the term *resistance* will often be used where an engineer might prefer to see the term *impedance* used. How-

tion, etc.) there is an optimum value of load resistance which the plate circuit of the tube must work into for best results. Load resistance is the resistance to which the tube delivers power. See figure 2. It is the resistance coupled or reflected back into a plate tank circuit by an antenna or the grid circuit of a succeeding amplifier stage. If a given amplifier works best into a high resistance load it simply means that that amplifier works best when delivering power in the form of high r.f. voltage and low r.f. current. By the same token, an amplifier that works into a low resistance load is simply one that best delivers power output in the form of low r.f. voltage but high r.f. current. The actual power, in watts, may be the same in each case; the question of load resistance merely indicates the relation between voltage and current in the output circuit of the vacuum tube supplying the power.

The General Conception

It is desirable to remember that a vacuum tube is nothing but a special form of a.c. generator. It is a power converter in the same sense as an ordinary motor-generator set. It takes d.c. power into its plate circuit and changes that d.c. into a.c. power of a given frequency. The change of d.c. power into a.c. power can never be 100% efficient, and the difference

between d.c. power input and a.c. power output appears as heat on the plate of the vacuum tube and is termed *plate loss*. All generators of electric power have some internal resistance

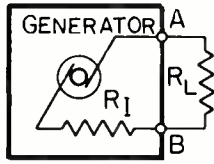

Figure 3

which may be indicated and handled by placing a finite resistance equal to that internal resistance in series with a hypothetical generator of zero internal resistance. See figure 3. Note that the internal resistance affects the voltage regulation of the generator. As the current drawn by the external load increases the voltage output of the generator decreases. By assuming any convenient value of the voltage output of the generator alone and a convenient value for the internal resistance of the generator, such as 100 volts output for the generator and 10 ohms internal resistance of the generator we can learn a fundamental law concerning all generators. By applying any value of external load resistance across the terminals A and B, the voltage, current, and thus the power dissipated in the load can easily be calculated by Ohm's law. If a very *high* value of load resistance is connected across terminals A and B the power delivered to the load will be quite low because the current through a high resistance is low and as the voltage can not go above 100 volts the product of voltage and current will be low. Also if a very *low* resistance is connected across A and B the power output will again be low. The current will be high but high current flowing

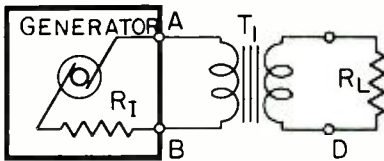

Figure 4

through the 10 ohms of internal resistance in the generator will cause the voltage output to drop way down and the product of voltage and current will again be low.

Experiment will soon show that in order to get most power into the load resistor connected across A and B it is necessary that the external load resistance R_L be *exactly* equal to the internal resistance of the generator R_1 . In other words the highest product of volts and amperes occurs when R_L equals R_1 . This is the fundamental generator law and applies to all types of electric generators, whether vacuum tubes or

rotating dynamos or alternators. Note that when the external load resistance equals the the internal generator resistance, just as much power is dissipated in the internal generator resistance as is dissipated in the external load. As half of the total energy output of the generator is supplied to the load and the other half is dissipated in the generator itself the efficiency of the generator is only 50%. When vacuum tubes are used as generators a compromise must be made between maximum power output and generator efficiency. This compromise is effected by running the generator into a load resistance somewhat higher than the internal generator resistance. The optimum load

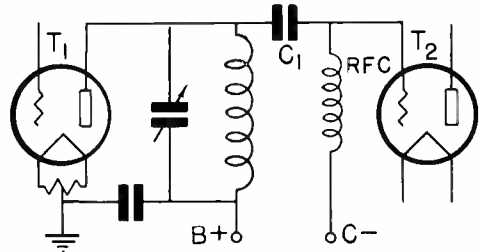

Figure 5

resistance for a class C amplifier usually runs from two to four times the internal resistance of the class C generator itself. As the total power output of a generator divides between the internal and external resistances in proportion to the resistances of each, the higher the external resistance, the higher the generator efficiency and the less power is lost in the generator for a given input.

Therefore to get the best compromise between generator efficiency and power output the external load resistance into which the generator looks must be adjustable over rather wide limits.

The Transformer Conception

An ordinary transformer is a simple device familiar to all amateurs, but few can state accurately the fundamental function of a transformer. The function of a transformer is to transform a low resistance into a high resistance or vice-versa. Of course, a transformer transforms power from high voltage at low current into power of low voltage at high current, but what is that but transforming the resistance of a low resistance load into the equivalent of a high resistance load reflected across the high voltage terminals of the transformer?

Thus when it is necessary to connect a high resistance load to a low resistance generator it is desirable to place a transformer between the

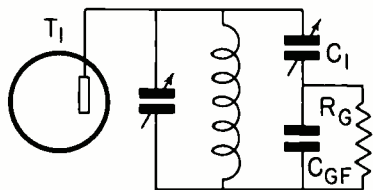

Figure 6

load and generator, as in figure 4, so that the load *reflected back* into the generator is exactly that value of load resistance into which the generator works best. It is obvious that a 440 volt electric heater that is designed to handle 4400 watts of power will not draw that power from a 110 volt generator. Its resistance is too high compared with that of the 110 volt generator. However, if a transformer steps up the 110 volt output of the generator to 440 volts the heater will draw its normal load from the generator. Note that in talking about the transformation of resistance we start with the load and work back toward the generator. The transformer *steps up* the voltage output of the generator; looking toward the load but more strictly it *steps down* the resistance of the load looking back toward the generator.

If the ratio of transformation of the transformer were variable, we could make the load on the generator anything we liked. That is just what we do when we vary the coupling between a driver and a driven amplifier stage in a transmitter. Varying coupling between a vacuum tube generator and a load simply means that the resistance reflected back into the plate circuit of the driver stage is being varied by changing the resistance transformation of the interstage coupling device. All interstage couplers are the equivalent of a simple transformer, whatever form they may take.

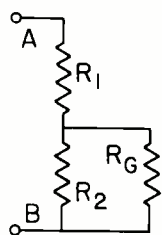

Figure 7

Grid resistance is the average resistance of the grid circuit of the driven stage. If the grid of the driven stage were not driven positive with respect to the filament (class A operation) the grid would not intercept electrons from the

filament and there would be no flow of grid current. If there were no flow of d.c. grid current it would take no *power* to swing the grid, merely voltage, and the grid resistance would be infinitely high. However, all efficient class B and class C driven stages utilize positive grid excursions so that d.c. grid current flows back to filament through the external grid circuit, which includes the negative bias supply. The effective grid resistance includes the average voltage drop from grid to filament *during the time the grid is positive, with respect to the filament*, in series with the resistance of the negative bias supply. When the bias is supplied from batteries or a separate bias pack the resistance of the bias supply is rather difficult to determine due to the fact that the current is

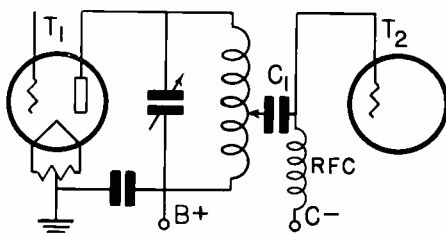

Figure 8

being *forced into* the bias supply instead of being *drawn out* of the bias supply. In other words, it is *charging up* the bias supply, not discharging it. It might be said that the grid offers a *negative* resistance to the bias supply. In any case, the equivalent resistance of the bias supply may be determined by dividing the total d.c. bias voltage by the d.c. grid current. This gives the value of grid leak resistor which could be used to replace the bias supply, of whatever form it might take.

We are not interested in the *exact* value of the grid resistance of the driven stage. It is merely desirable to know whether the grid resistance is low, medium, or high, relatively speaking.

Grid resistance is largely determined by the amount of grid current that the grid of the driven stage intercepts for a given positive voltage swing. The lower the grid current for a given voltage swing, the higher the grid resistance. While no absolutely accurate rule can be laid down, in general, a high μ tube (μ above 16) has a low grid resistance while a low μ (μ below 8) tube has a high grid resistance. It follows that the medium μ tubes (8 to 16) have medium grid resistance.

Saying the same thing another way, a high



μ tube requires few grid volts but many grid ma. for proper excitation while a low μ tube usually requires lots of grid voltage but little grid current for the same power output and efficiency. The actual power in watts may be the same for the two cases, because grid driving power is the *product* of grid voltage and current. Remember that the μ of a tube has absolutely nothing to do with the grid driving power that must be supplied by the driver stage. However, the μ is an indication as to the grid resistance. The grid resistance of the driven stage must be transformed back, by the action of the interstage coupling device, into the optimum plate load resistance for the driver stage.

Suppose that the driver tube requires a medium value of optimum load resistance. If

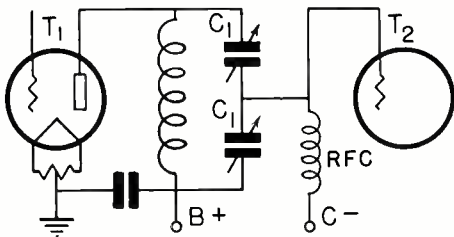

Figure 9

the driven stage uses a low μ tube (high grid resistance), some voltage step up may be necessary in the output coupler. On the other hand if the driven stage uses a high μ tube (low grid resistance), some voltage step down will be necessary. Thus the amount of step up or step down in the interstage coupler will depend on two factors: first, the optimum plate load resistance for the driver; and second, the grid resistance of the driven stage.

Another fairly accurate rule of thumb which may be useful within limits is the relationship between μ of the driver tube and its optimum plate load resistance. A high μ tube usually has a high plate resistance and thus requires a high value of plate load resistance. Also, a low μ tube usually has a relatively low plate resistance and thus requires a low value of plate load resistance.

Thus note that a tube with a low grid resistance usually has a high plate resistance and a tube with a high grid resistance usually has low plate resistance. Therefore it follows that if a one-to-one voltage or resistance ratio is used in the interstage coupler a high μ tube could not drive properly another high μ tube. Also, a low μ tube could not drive properly

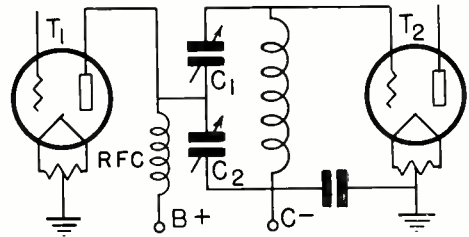

Figure 10

another low μ tube. However, sometimes a one-to-one coupling ratio is satisfactory between a low μ driver and a high μ driven stage, or else between a high μ driver and a low μ driven stage. Thus if a multistage transmitter used a one-to-one ratio between all stages the tubes used in the amplifier stages should be alternately low and high μ .

However, plate voltage has such a marked effect on both the optimum plate load resistance and the grid resistance of an amplifier stage that no practical transmitter would use a one-to-one coupling ratio between any two stages except by accident. It is much simpler to use tubes and plate voltages that are available and then vary the coupling ratio of the interstage coupler in order to get efficient results.

Interstage Couplers

The ideal interstage coupler would have the following characteristics: It would be simple and low in cost. It would have low inherent losses. It would effectively filter out undesired harmonics generated in the driver stage. *It would have a simple adjustment of the coupling ratio.* This is one of the most important points. Two identical transmitters using the same tube line up will usually require different coupling ratios due to slight differences in plate and bias voltages. This helps to explain why

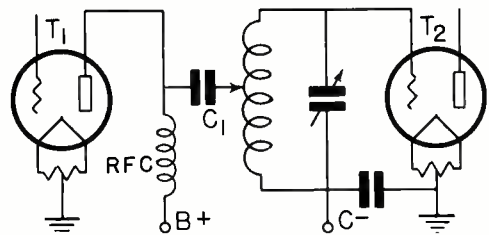

Figure 11

some transmitters built from a magazine description persist in acting differently than indicated in the article.

The ideal coupler should also preferably allow series feed of plate and bias voltages in order to avoid the use of r.f. chokes. It should be free from hand capacity while tuning or



adjusting. It should be compact, and should have a minimum external field to affect neutralizing and give objectionable feedback. There should be a minimum of connections to change when changing bands.

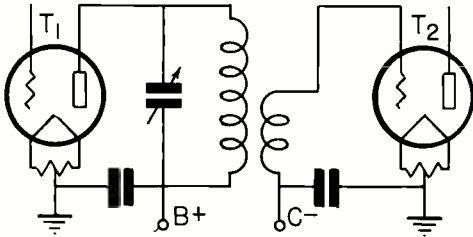

Figure 12

There is no ideal coupling system which lives up to all the desirable characteristics outlined above. All systems have some advantages and some disadvantages. There is one important point often overlooked. *Practically all coupling systems are capable of giving very good results when properly built and adjusted.*

Capacitive Coupling

The fundamental capacitive coupling circuit is shown in figure 5. To operate properly, condenser C_1 should be considered as a *blocking* condenser and not as a *coupling* condenser. It should usually be about .002 μfd s. and may be as large as .01 μfd s. for 160 meter operation. This gives a one-to-one coupling ratio. However, many amateurs make C_1 a small variable condenser of perhaps 25 to 50 μfd s. in order to exercise some control over the coupling between the driver and the driven stages. This is usually bad practice, for the same reason that a very high resistance voltage divider is bad practice in a tapped power supply.

It is obvious that two 5 megohm resistors could be used in series to establish the 100 volt tap on a 200 volt power supply. However, for most applications two 10,000 ohm resistors would give better results because slight changes in the circuit tapped on to the 100 volt point would then have less effect on the voltage at that point. In other words, the voltage regulation would be much better with the low resistance voltage divider.

The use of a small variable condenser at C_1 in figure 5 is undesirable because the circuit corresponds roughly to a very high resistance voltage divider. In figure 6 is shown the equivalent circuit of figure 5. (See also figure 7.) Note that C_1 is part of a voltage divider whose other element is the grid to filament capacity of the driven tube, marked C_{gf} in the diagram.

The grid resistance of the tube is shown shunted across C_{gf} and is termed R_g . Note that relative small changes in the grid resistance of the driven tube can cause wide changes in the r.f. grid voltage which appears across C_{gf} . This is due to the fact that the current through C_1 and C_{gf} in series is very small due to their low total capacity in series. The smaller the capacity of those two condensers the higher is their r.f. resistance (reactance) and the normal changes in grid resistance R_g caused by changes in plate voltage or plate loading of the driven stage will have a very marked and detrimental effect on the coupling ratio between the driver tube T_1 and the driven tube T_2 . Figure 7 shows the equivalent circuit of the voltage dropping circuit of figure 6. R_1 of figure 7 corresponds to the reactance of C_1 of figure 6; R_2 corresponds to the reactance of C_{gf} , and R_g is the same in both illustrations. The higher the total resistance of R_1 and R_2 in series, the more effect on the voltage applied to R_g when R_g is varied.

The circuit shown in figure 8 is a big improvement over figure 5. The grid lead of the driven stage is tapped down on the plate tank coil of the driver stage at a point where the proper ratio of coupler transformation occurs. Blocking condenser C_1 should be about .002 μfd s. Incidentally, note that in all capacitively coupled circuits, the required step up or step down of resistance occurs by autotransformer action. The circuit of figure 8 is exactly the same as those of figures 5 and 6 as far as results are concerned, but the circuit of figure 8 maintains optimum adjustment much better

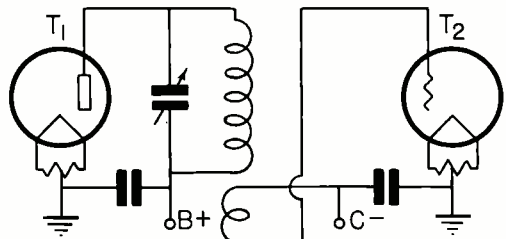

Figure 13

than the more widely used circuit of figure 5. However, the circuit of figure 8 still has two disadvantages: Tapped coils are not easily variable and also certain types of driven tubes such as 46's, etc., have a bad habit of generating parasitic oscillation when their grid is tapped down on the preceding tank coil. The circuit of figure 9 gets away from these two objections. Two relatively large condensers are used in series across the driver plate tank coil in order



to tune it. The coupling ratio is adjusted by increasing capacity in one condenser and then restoring resonance with the other condenser. Note that this arrangement is quite similar to the Collins antenna coupler.

The higher the capacity of C_2 (and thus the lower the capacity of C_1 , when tuned to resonance) the greater the voltage step down from the driver plate to the driven stage's grid. An insulated shaft must be used on the rotor of C_1 in order to avoid hand capacity at that point. On 160, 80 and 40 meters C_1 and C_2 can be almost anything between 200 and 300 μ fd. On the higher frequencies less capacity will be necessary to preserve proper circuit Q in the driver plate tank.

Note that the arrangements of figures 8 and 9 both provide for voltage step down from the driver plate to the driven grid. When a low μ tube is used to drive another low μ tube some voltage step up may be necessary. In that case we just turn the autotransformer around as in figures 10 and 11. The circuit of figure 10 is derived from figure 9 and that of figure 11 is from figure 8. Note that the r.f. choke has been moved from the grid circuits of figures 8 and 9 to the plate circuits of figures 10 and 11. This is highly desirable because if shunt feed of one circuit is used always be sure to shunt feed the circuit with the lowest voltage across it, which is the same as saying the one with the lowest resistance (impedance). Naturally the circuit that is tapped down on the tank circuit will have the lowest r.f. voltage to ground across it; so therefore that is the one to shunt feed if either must be so fed.

Capacitive coupling is the simplest form of interstage coupling and its only important disadvantage lies in the fact that series feed of both grid and plate potentials is impossible. It also has a disadvantage at the higher frequencies due to the fact that undue crowding of the driver and driven stages usually becomes necessary to keep the length of leads down.

Inductive Coupling

The fundamental inductive coupled circuit is shown in figure 12. This circuit gets away from r.f. chokes and is useful where bands are to be changed rapidly over a wide range where r.f. chokes could not be expected to work efficiently. It is obvious that no one r.f. choke can be expected to do an equally good job on

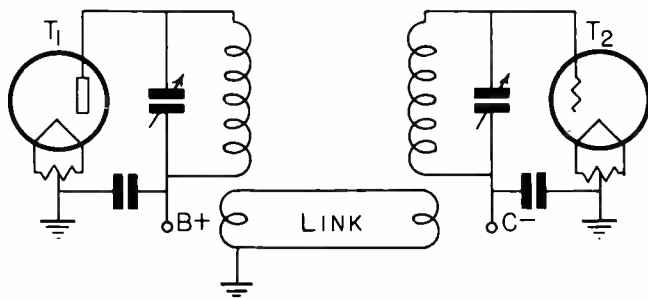

Figure 14

160 and 10 meters as well on all the bands in between. The coupling ratio is quite difficult to adjust with inductive coupling and the only answer is to use the good old cut and try system until the right turns ratio is obtained. Inductive coupling is used mostly in production transmitters where once the right combination is obtained it can be cheaply copied.

Little discussion of inductive coupling is necessary, but a few tips may help. Very close *inductive* coupling between primary and secondary is desirable but *capacitive* coupling between windings should be kept at a minimum to avoid neutralizing troubles. Figure 13 shows the circuit of figure 12 redrawn so that the connection to the grid is farthest away from the plate end of the plate tank coil. This minimizes capacitive coupling.

The plate circuit of the driver stage should be the tuned circuit when a voltage step down is used between driver and driven stages. When a voltage step up is necessary, tune the grid circuit of the driven stage. In other words, always tune the winding with the most wire on it.

Note that it is bad practice to attempt to tune both windings when both are on the same form. With such close coupling it will be almost impossible to get anything like a real resonant peak to the tuning. There will be a great deal of interlock in tuning and the result will be a double hump or a flat-topped tuning curve, which is undesirable in a transmitter, although sometimes desired in a receiver.

Link Coupling

The fundamental link-coupled circuit is shown in figure 14. There is a tuned tank circuit for both the driver plate and the driven grid circuit. These two tanks are isolated from each other so that there is no direct inductive or capacitive coupling between them. The only coupling between them is through the low impedance (there is that word again) link cir-

[Continued on Page 74]



An Economical 10 Meter Phone-C.W. Rig

By FRANK C. JONES

This transmitter is capable of putting out a 15 to 20 watt carrier on phone and 40 to 60 watts of c.w. on 10 meters. 15

to 20 watts on phone is sufficient for extreme d.x. work on the 10 meter band during the periods in which this band is open. Grid bias modulation is economical and does not tie up much capital in modulation equipment on a good c.w. transmitter. A good quality single-button microphone working into a 2A5 pentode modulator tube will give ample output to grid modulate a pair of 801's or 210's in the final stage. Crystal control is used to provide stability.

The exciter has a 53 tube as a combined 40

Because of the uncertain nature of the band and the possibility that it might up and "never come back no more," or at least for a good long time, many amateurs are reluctant to tie up much equipment in a 10 meter transmitter. The rig described herewith was designed for the amateur whose present transmitter is not particularly adaptable for 10 meter operation and who wants to get on "ten" with a good signal as cheaply as possible.

meter crystal oscillator and 20 meter frequency doubler. Unity coupling drives a '10 either as a neutralized buffer

for 20 meter band operation, or as a regenerative doubler to 10 meters. For the latter purpose the neutralizing condenser is set at from 2 to 3 times as high a capacity as for normal neutralization. The 10 meter output of this '10 under these conditions is about 15 watts, and is enough to drive the final stage on c.w. On phone this has to be reduced, as only about 1 to 2 ma. of grid current should flow (without speech). This final stage grid excitation is adjusted by means of sliders on a plate voltage dropping resistor in the supply

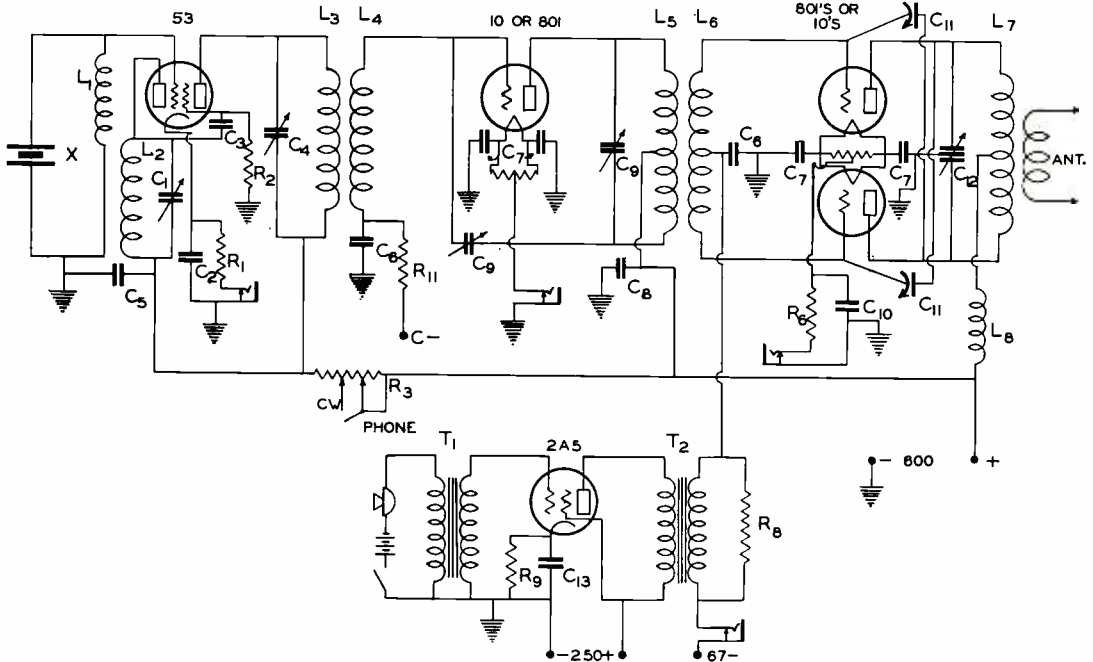

The R.F. and Speech Layout

- L₁—2.1 mh. r.f.c.
- L₈—1.8 mh. r.f.c., 200 ma.
- L₃ to L₇—See coil table
- T₁—Mike to grid trans.
- T₂—Class B input trans.
- C₁—50 μfd. midget
- C₂—.01 μfd. paper
- C₃—.0001 μfd. mica

- C₄—50 μfd. midget
- C₅—0.1 μfd. 1000 volt
- C₆—.001 μfd. mica
- C₇—.002 μfd. mica
- C₈—.01 μfd. mica
- C₉—35 μfd. double spaced midget
- C₁₀—8 μfd. 450 volt elec-

- trolytic
- C₁₁—15 μfd. double spaced midget
- C₁₂—80 μfd. per section. transmitting type
- C₁₃—10 μfd. 25 volt electrolytic
- R₁—400 ohms, 10 watts

- R₂—50,000 ohms, 2 watts
- R₃—10,000 ohms, 35 watts with slider
- R₄—15,000 ohms, 10 watts
- R₅, R₇—100 ohms, c.t.
- R₆—600 ohms, 20 watts
- R₈—10,000 ohms, 10 watts
- R₉—400 ohms, 2 watts

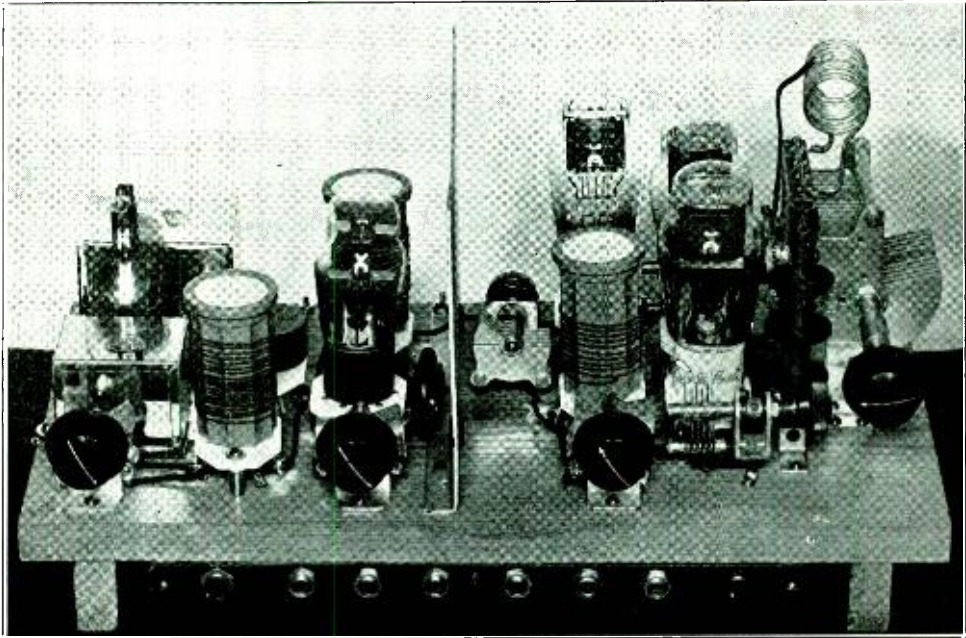

The unity coupled 10 meter 801 transmitter. 20-25 watts phone, 75-100 watts c.w.

lead to the 53 tube. On c.w., as high as a 450 volt plate supply may be used (measured from plate to ground) if a special power cut 40 meter crystal is used. On phone this voltage is reduced until the output of the 10 doubler is just sufficient for proper modulation. A small tog-

COIL TABLE

L ₂	(40 m. osc. plate)—20 t. no. 20 d.s.c. 1½" d., 1¾" long.
L ₃	(20 m. doubler plate)—10 t. no. 20 d.s.c. 1½" d., 1½" long.
L ₄	(20 m. grid coil)—10 t. no. 24 d.s.c. interwound with L ₃ .
L ₅	(10 m. plate coil)—5 t. no. 20 d.s.c., c.t., 1½" d., 1" long.
L ₆	(10 m. grid coil)—5 t. no. 20 d.s.c., interwound with L ₅ .
L ₇	(10 m. final plate)—9 t. no. 10 wire, c.t., 1⅝" d., 2" long.

gle switch can be used to change from c.w. to phone, the variable 10,000 resistor being located underneath the baseboard.

The oak baseboard is 17" x 9" x 1", mounted on end blocks in order to place all resistors, current measuring jacks, and by-pass condensers underneath. One aluminum baffle shield (grounded) separates the 53 exciter unit from the output stages. As shown, it isolates the final tank coil from the buffer input coil to allow 20 meter operation. It is not needed on 10 meters. The final stage and its driver are crowded into a small space in order to have short plate leads. The final plate leads cross over each other to

opposite stator sections in order to have a symmetrical neutralizing circuit, as this final stage must be properly neutralized. Type 10 tubes or 801's may be used, preferably the latter as their plate dissipation and 10 meter efficiency is higher. If 10's are used, the bases should be slotted with a hacksaw between prongs in order to improve the efficiency, obtain neutralization under operating conditions and also to prevent blistering on the base. Ceramic base type 10's are now offered by one manufacturer at a slight additional cost.

An 83 rectifier system or two 80's with parallel plates as half-wave rectifiers may be used for power supply. On phone the total plate current is about 160 ma., while on c.w. it will be as high as 250 ma. About 600 volts plate supply is as high as can be used safely on 801's and between 500 and 600 on 10's. Separate 7½ volt windings are needed for the final and buffer stages.

The antenna coupling has to be quite tight for phone operation in order to obtain upward swing of antenna current. The plate current should remain nearly steady, and a few ma. of grid current may flow on peaks of modulation. The fixed grid bias should be set for plate current cut-off, which means about 67½ volts for a 600 volt plate supply. An additional

[Continued on Page 82]

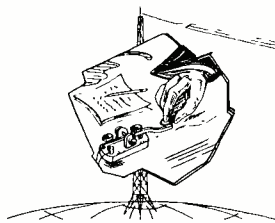

CALLS HEARD AND DX DEPARTMENTS

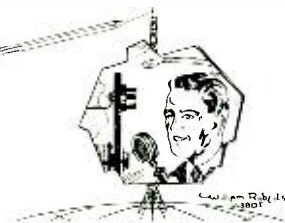

Numeral suffix indicates "R" strength. Send Calls Heard to Calls Heard Editor*, not to Los Angeles.

**Donald W. Morgan, B.R.S.-1338, 15 Grange Road,
Kenton, Middlesex, England**
January 1 to January 31, 1936

(14 mc. phone)

W 1AKR-6; 1CHG-7; 1CMD-7; 1DIT-7; 1DR-8; 1ESU-7;
1GJ-8; 1IAN-6; 1IAQ-7; 1IFD-8; 1ILQ-7; 1ILU-7;
1LTC-8; 1JK-7; 1KJ-7; 1NG-7; 1ZD-8; 2AFC-6; 2AIE-7;
2AII-7; 2AJ-7; 2AMG-7; 2BSD-8; 2CFU-8; 2CKZ-7;
2CLS-7; 2DVU-8; 2DWC-7; 2EDW-7; 2EXN-7; 2EZC-7; 2FWK-8;
2FYD-7; 2GAT-7; 2GFH-7; 2GNT-8; 2HAU-7; 2HBI-7; 2IWT-7;
2IXY-7; 2KR-7; 2OA-8; 2OJ-7; 3ABN-8; 3APO-6; 3BDA-7;
3BFH-8; 3DM-7; 3DMD-8; 3DPC-7; 3EGU-7; 3E0Z-8; 3EXC-7;
3LN-7; 3SFP-6; 4AH-7; 4AHH-7; 4BY-6; 4CLH-6; 4CPG-7;
4OC-7; 8A0C-6; 8AW-6; 8CMA-8; 8KT-7; 8LAC-7; 8LFE-7;
8LGY-7; 8MNJ-7; 8QYT-7; 9ARE-7; 9FJ-7; 9HCR-6; 9PLS-7.
— C02HY-6; C060M-7; CT1BY-8; EA3ER-8; HB9AY-7; HB9M-7;
HI5X-8; HI7G-7; K4SA-8; LA1G-8; LA1V-7; LA2Y-7; LA2Z-8;
L4AR-7; LY1J-7; OK2PMS-7; OZ1I-7; SM5TC-8; SP1CS-8;
SULCH-7; VE1AW-8; VE1CR-7; VE2CA-7; VE2CJ-7; VE3G0-7;
VO1I-8; YM4AA-7.

**Joe Tomczyk, W9DBC, 312 14th Ave. N.E.,
Minneapolis, Minnesota**

January 1 to January 31, 1936

(28 mc.)

CM2FA; D4ARR; D4GWF; EA4A0; F8CT; F80Z; G2HG; G2MV;
G2YL; G5BY; G5FV; G5LA; G5VU; G6LK; G6RH; G6WY;
G6ZM; HJ3AJH; IE8B; IE8JNJ; K7UA; LU9AX; OA4B; OK1BC;
PA0XR; PA0PCT; VE1AQ; VE1BQ; VE1CO; VE1DZ; VE1EA;
VE5BE; VE5FU; VE5HC; VE5IQ; VE5KC; VE5QA; VK3YP;
VO4Y; VP5PZ; XE1AY; XE1CM; XE2C; YM4AA; ZS2A.

**Alice R. Bourke, W9DXX, 2560 E. Seventy-second
Place, Chicago, Illinois**

January 10 to February 10, 1936

(14 mc.)

CM2AD-7; CM2BG-5; CM2D0-6; G5WG-5; HC2M0-6; HR2UK-6;
K5AF-7; K5AL-7; NY1AA-7. — VE 1DQ-6; 2CB-6; 2DV-7;
2FI-7; 2JD-5; 2LL-6; 3JE-6; 3UW-6; 4EM-6; 4HU-6; 4IZ-6;
4KU-7; 4MB-6; 4QZ-7; 4VD-8. — VP1J0-6; VP1JR-6; XE1DA-7.

(28 mc.)

W 1HPW-6; 5AGP-7; 5ELL-7; 6ANN-7; 6BAM-8; 6BAY-7;
6BJD-7; 6CXW-9; 6DGP-5; 6D10-7; 6DL-6; 6FEX-6; 6FJT-6;
6GRX-8; 6GTD-6; 6HXX-6; 6IDV-7; 6JUJ-7; 6JPU-7; 6KB-7;
6KBD-6; 6KR-6; 6KUI-7; 6NFA-7; 6WB-6; 6WX-6; 7AVV-8;
7BCI-9; 7BYW-8; 7DAA-7; 7DUX-6; 7EFB-7; 7ESN-7; 7HS-6;
9CJT-5. — CM2AF-7; CM2BG-5; D4CSA-5; EA4A0-7; FA8BG-6;
G6RH-7; HC2M0-6; K5AL-5; LU9AX-6; OA4B-8; ON4LX-5;
VE1DZ-7; VE2CB-6; VE4BF-6; VE4GW-9; VE4LQ-5; VE4LZ-6;
VE4QZ-8; VE4UY-7; VE5KC-6; VP5PZ-7; ZS1H-6; ZS2A-5.

**Eric W. Trebilcock, BERS-195, Telegraph Station,
Tennant Creek, North Australia**

December 1 to December 31, 1935

(14 mc. phone)

W 2CPA-4; 2GVZ-4; 2UK-6; 4CJ-5; 4DBC-3; 4DRD-4;
4DVN-4; 4EF-5; 4FT-6; 5VV-5; 6ANN-6; 6CXW-6; 6FMY-5;
6FT-4; 6GHU-5; 6KQL-5; 6KRI-7; 6LBW-7; 8AAU-4; 8ADG-4;
8CRA-5; 8DCP-5; 8DQN-5; 8DWI-4; 8DXN-4; 8OIR-5; 8OSL-4;
9AHX-5; 9SMB-4. — F8E0-3; FB8AB-5; G5QA-4; G7I-7;
HC1FG-6; HI5X-5. — J 2CB-5; 2CF-4; 2IR-5; 2IZ-5; 2LB-7;
2LJ-4; 2LL-5; 2ME-4; 3DR-7; 3DL-6; 3EN-5; 3FI-6; 7NC-7;
8CA-5; 8CD-6. — K 4BRN-5; 4DDA-5; 4SA-5; 5AC-4; 6BHL-6;
6CJG-6; 6FA0-4; 6GNW-7; 6KKC-5; 6LJB-6; 6NEK-6. —
KAIAN-4; KA1DD-4; KA1DS-5; KA1ER-6; KA7AD-7; NY1AB-4;
OA4J-4; OH30J-6; OH3NG-3; OH5NP-5; OK2AK-3; OM1TB-6;
PK1MD-7; SU1AL-5; SU5NK-6; VE3WA-4; VS2AG-6; VS3AC-7;
VS3AE-5; VS4AC-7; VS6AF-5; VS6AQ-6; VS6AX-5; VS6BD-7;
VS7JW-7; VU2AU-4; VU2BY-8; VU2EB-4; VU2ED-6; VU7FY-7;

*George Walker, Assistant Editor of RADIO, Box 355, Winston-Salem, N.C., U.S.A.

X1AM-7; XU1A-6. — ZL 1AK-6; 1CK-6; 1DV-6; 1GX-6;
1HY-6; 2BP-5; 2BZ-6; 2FA-6; 2FY-8; 2GN-5; 2JU-6; 2OD-4;
2OQ-5; 2PV-4; 2QM-5; 2QT-5; 3AB-5; 3AH-7; 3AJ-6; 3AZ-5;
3CC-6; 3CU-4; 3GN-5; 3GR-5; 3HK-8; 3JU-5; 4A0-5; 4BQ-7;
4CK. — ZS2X-4; ZU6P-4.

(7 mc.)

W 1AAD-3; 2CMY-3; 2FMP-5; 3DMQ-4; 4AGX-4; 4DVN-5;
GAEW-7; 7FKZ-6; 6KRS-5; 6TI-6; 8BNY-5; 8CFP-4; 8CNZ-7;
8LEC-6; 8LXZ-5; 9MIN. — CM2AF-5; CN8MN-4; CR7AU-5;
CR7AY-4; CR7MB-4; CT1BG-5; CT1BQ-6; CT1EQ-4; CT1FZ-4;
CT1IS-3; CT1LZ-6; CT1AN-4; CUL2-5; D4BXV-4; D4CPF-5;
D4JRB-4; D4LIM-4; D4MNL-5; D4NAP-4; D4NXR-5; D4TKP-4;
D4UYD-4. — EA 1AN-5; 1BC-4; 3AB-4; 3EE-5; 4BM-6;
4BV-4; 4CV-6; 5BC-3; 5BD-3; 5BL-4; 7AK-4; 7AS-5; 7AV-4;
7BC-4; 7BE-4; 7BG-5. — EI6F-4; EI8B-4; F3AU-5; F8J-4;
F8KJ-4; F8LX-3; F8NY-5; FB8AA-5; FB8AD-5; FR8VX-5. —
G 2DQ-5; 2JU-4; 2NA-6; 2PL-3; 5IS-3; 5JM-5; 5JX-4; 5OJ-3;
6CW-5; 6NJ-5; 6OX-4; 6PY. — HAF2G-5; HAF8C-5; HB9AT-4;
KA1TS-6; KA7AD-5; KA9EP-5; KA9WX-8; LY1J-4; OE1ER-4;
J2LL-5; J3CR-5; J4CP-4; J5CC-8; K6AKP-7; K6CKG-6;
K6ESU-5; K6GXB-7; K6NDH-7; KA1EF-8; KA1KG-5; KA1MG-8;
OK3AH-4; OH30D-3; OK1BC-5; OK2KP-4; OK2OP-4; OK3VA-5;
ON4AU-5; ON4CJJ-4; ON4D0A-5; ON4FE-4; OS1BR-5; PA0AZ-7;
PA0DC-6; PA0JV-6; PA0XR-5; SP1DE-5; SP1FI-4; SU1FS-5;
SU1KG-4; SU1TM-3; SU5NK-4; SX3A-4; T15MR-4; U1AP-3;
U3AS-4; U4L-4; U6MC-4; U9AV-5; U9MF-4; UK3AH-3;
VE2TX-6; VQ2BI-4; VQ2WAB-3; VQ8AF-5; VQ8AG-5; VR1AM-5;
V57RP-7; VU2CB-5; XU2HY-4; XU2JM-5; XU3ST-6; XU6LN-6;
XUSAG-7; XU8RR-7; XU8SM-6; ZE1JY-3; ZS4E-4; ZS6AC-5;
ZT5P-5; ZT5Z-6; ZT6AM-4; ZU1T-5; ZU5AC-7; ZU6P-5.

**Eugenio Alves de Moura, CT1ZZ, Rua de Cedofeita,
N. 968, Porto, Portugal**
December 1 to December 26, 1935

(7 mc.)

W 1EBC-6; 1BKI-5; 1BUX-5; 1CFU-6; 1DHE-7; 1INR-5;
1HJQ-5; 1SI-6; 2BJ-7; 2BZC-5; 2CJM-6; 2DTB-6; 2ECO-5;
2EIL-5; 2FKK-6; 2FV-6; 2FW-7; 2GHO-5; 2GIZ-6; 2HHC-5;
2HRP-5; 2HUH-6; 2HW-5; 2IA-5; 2IBJ-6; 2IGM-5; 2IIF-5;
2IIL-6; 2OC-7; 3BAN-5; 3DH-7; 3DLR-5; 3D0Y-6; 3EGA-6;
3ETI-6; 3EXB-4; 3EYS-6; 3FCQ-6; 3FGA-5; 3QZ-6; 3RLH-5;
3UVA-5; 4CDE-4; 4DAH-5; 4DEK-5; 4DML-6; 8A0N-7; 8BCT-6;
8BTI-7; 8BYI-5; 8CNC-7; 8HVO-6; 8UMP-6; 8KPB-5; 8LNF-5;
8NBZ-6; 9FCN-5; 9JRO-5; 9LRO-4; 9MT-5; 9NDB-5. —
CM2GG-5; CM7FR-5; CM9CK-5; K4CV-4; VE1EP-6; VE2A-5;
VE3OR-5; VK3MK-6.

**Eric W. Trebilcock, B.E.R.S.-195, Telegraph
Station Qtrs., Tennant Creek, North Australia**

(14 mc. phone)

HP1A-5; W7CGR-6.

(7 mc.)

W 6AZK-4; 6HDV-4; 6HUV-5; 6LJA-4; 9MIN-3. — CT1ED-4;
EA3EG-4; EA5BK-5; F8JD-3; F8SW-4; FA8PW-6; G6HW-3;
KAI1G-8; PA0YS-4; SU5NK-4.

(14 mc.)

W 2BSR-6; 2CZV-6; 2DTB-7; 2FU-5; 3BES-5; 3BLQ-7;
3BSB-4; 3DMQ-7; 4AJY-5; 4TR-3; 5ADZ-5; 5AVM-6; 5BMM-5;
5CEN-5; 5DDP-6; 5DVI-4; 5EZA-5; 5QL-6; 5QU-5; 5RR-5;
6ABB-3; 6BEM-5; 6BVC-6; 6BXL-5; 6CQK-5; 6DEC-5;
6DIO-6; 6FFP-6; 6GAL-4; 6GZE-6; 6HJT-4; 6JLU-4; 6JSG-6;
6JYD-5; 6JZL-4; 6KJG-5; 6KOU-4; 6KTH-4; 6LWU-5; 7AFN-6;
7ALV-3; 7BBW-6; 7BLR-4; 7BRL-4; 7CNA-6; 7D0X-5; 7QC-6;
8GSZ-4; 8IWI-5; 9ARL-6; 9BEU-6; 9BTW-5; 9KG-4; 9LQU-3;
9MIN-6. — F7CGV-7; F8EF-4; F8EJ-5; F8BC-6; 6GDL-5;
6GWY-4; HJ3AJH-5; HP1A-6. — J 2CL-8; 2GR-5; 2HQ-6;
2IT-6; 2KJ-7; 2LB-4; 2LK-6; 2LU-7; 2ME-5; 3FJ-7. —
K5AC-4; K6CIB-6; K6LHK-6; KAI1B-6; OH3NP-5; OH20J-5;
ON4RX-4; PA0JB-4; PK1CI-7; PK1DF-6; U0HR-5; U2NE-3;
U3AG-5; VE3QD-5; VE4FI-7; VE5BI-6; VE5HA-4; VE5KC-3;
VP5PZ-6; VR4BA-8; VS1AJ-4; VS3AC-3; VU2BY-4; X11AG-5;
X1BA-6; X2N-5; XU2JM-6; ZB1E-5; ZB1H-6; ZL2BZ-6;
ZL2JA-5.



Robert Douglas Everard, Westgate House,
Great Gransden, Sandy Beds, England
December 6, 1935 to January 6, 1936

(3.5 mc. phone)

W 1ADM-9; 1AJZ-7; 1AQM-6; 1AYP-6; 1BES-9; 1BMT-8;
1BN0-6; 1CBX-6; 1DBM-7; 1DVR-6; 1DXD-6; 1EEV-6;
1FCE-7; 1FR-7; 1FV0-5; 1HZU-6; 1LI-7; 1IYI-6; 2AU-7;
2AUF-5; 2AVS-5; 2BJT-6; 2BTZ-6; 2CZO-6; 2EOY-7;
2EVL-5; 2HS-8; 2HYP-8; 2JP-6; 2NW-7; 3AHR-7; 3AN-7;
3AXR-8; 3BJ-7; 3BJP-7; 3BMS-7; 3CWG-6; 3DKX-8; 3DMR-7;
3D0-8; 3DRY-6; 3EEY-6; 3EFS-7; 3EFU-6; 3EHY-7; 3FEQ-6;
3FUJ-7; 3IS-6; 3LA-6; 3NK-6; 3WX-7; 3ZY-6; 4AGB-6;
4AVH-6; 4COT-6; 4CPG-6; 4CVQ-6; 4NN-6; 4PT-4; 5DVK-6;
5MS-6; 8AY-7; 8BRC-7; 8BWH-6; 8BXB-7; 8CTN-6; 8CUO-6;
8DK-7; 8EGN-6; 8GLC-6; 8IKA-5; 8JMM-6; 8JDE-6; 8KIR-7;
9BBU-7; 9ECU-6; 9LSU-6; 9NLP-6; 9PZ-6. — VE180-7;
VE1CA-6; VE1DR-7; VE1EI-9; VE2HK-6; VE2HN-6; VE2RI-5;
VE3WV-5.

(7 mc. phone)

CN9MI-7; CN9MW-7; DE6DK-8; EA8AD-6; EA9AH-8; FA3FF-7;
FA3JZ-7; FA8BE-8; FA8CC-9; FA8CE-7; LU4BC-6; SU1CH-6;
SU1GP-6; T1IAF-6; T1Z0F-6; VV5AM-9.

(14 mc. phone)

W 1ACQ-7; 1AF-6; 1AGW-8; 1AJZ-9; 1AKR-6; 1ARC-6;
1ATD-6; 1AWD-7; 1BDS-7; 1BIC-6; 1BLU-7; 1B00-7;
1CAV-7; 1CCZ-7; 1CHG-7; 1CJF-6; 1CND-9; 1CRW-7;
1ESU-6; 1FH-6; 1FV0-6; 1GBE-7; 1GJX-8; 1GR-7;
1HCM-6; 1HWB-6; 1IAS-7; 1ID-6; 1IGE-7; 1IMG-6;
1IYI-6; 1KJ-8; 1KK-7; 1KW-5; 1QV-8; 1ZD-7; 2AIE-6;
2AII-7; 2AIO-6; 2AJD-8; 2AMD-7; 2BAJ-6; 2BSD-9; 2BUP-7;
2CFU-7; 2CLS-7; 2CMT-6; 2CNL-6; 2CTK-6; 2CWC-6; 2DH-6;
2D0Z-6; 2DPA-7; 2DTE-6; 2DVI-6; 2DYR-7; 2DX-6; 2DXX-7;
2ELO-6; 2EUG-7; 2EXN-7; 2EZC-6; 2FL0-6; 2FWK-7; 2FYD-7;
2GDU-7; 2GFH-6; 2GMG-6; 2GNV-7; 2G0Q-7; 2GYM-6;
2HFS-8; 2HNA-6; 2HOY-6; 2HVG-6; 2ICU-7; 2IXY-8; 2JJ-6;
2KR-6; 2NW-7; 2OJ-7; 2UK-8; 3AER-6; 3AHS-6; 3ANZ-6;
3AP0-8; 3AUC-7; 3AXT-7; 3BDH-7; 3BFH-9; 3BIA-6; 3BMA-6;
3BNC-6; 3BPD-6; 3BRX-7; 3CBT-6; 3CC-8; 3CKT-6; 3CM-7;
3CMR-6; 3CNU-6; 3COP-8; 3CRG-7; 3CSJ-8; 3CXQ-6; 3DDC-7;
3DEK-7; 3EHY-7; 3EOZ-8; 3EVL-6; 3FBF-7; 3FF-5; 3FPB-6;
3HF-6; 3IX-6; 3LN-7; 3LP-7; 3MD-8; 3NK-8; 3PC-8;
3ZX-7; 4AHH-8; 3BQZ-6; 4COT-6; 4CPG-6; 4CQG-5; 4CRE-7;
4DVC-7; 4DLH-7; 4DQD-6; 4OC-6; 4PW-8; 4TW-6; 4ZF-7;
5ACF-6; 8AFG-6; 8ANN-6; 8AVD-6; 8CKY-6; 8CNA-6; 8CPC-7;
8CYT-6; 8DW-5; 8FHE-7; 8GAZ-5; 8HAF-7; 8HFW-6; 8IV-6;
8KQ-6; 8KQJ-7; 8LAC-6; 8LEI-8; 8MBW-6; 8MDU-6; 9ARK-7;
9BVK-7; 9DZP-6; 9EEL-6; 9KFA-6. — C02WZ-7; C060M-8;
C08YB-7; CT1BY-7; EA3ER18; EA2BW-8; EA8AF-7; EA9AL-7;
EA9AH-8; F8ZE-8; FA8BG-6; G2XV-8; G5ML-5; G6C0-5;
H15X-6; H17G-6; HB9AT-6; HB9AY-8; HB9B-8; K3SA-9;
LA1G-8; LA1V-8; LA2Y-8; LA2Z-8; LA3B-8; LA4N-6; LY1J-7;
NX2Z-5; OH5NG-7; OK2K0-8; OK3VA-8; VE1AX-5; VE1CR-8;
VE1DC-7; VE1DR-7; VE1DT-7; VE1GH-6; VE1JA-5; VE2BE-6;
VE2BG-7; VE2CA-7; VE2EE-7; VE2EW-6; VE2FG-6; VE2HK-6;
VE3HC-7; VE3IX-6; VE3LL-6; VE3OX-5; VE3TD-6; VE3UY-6;
V01I-8; VP2CD-5; VP9R-8; YM4ZAA-6.

J. V. McMinn, NZ16W, 12 Edge Hill,
Wellington, New Zealand
November 2 to December 30, 1935

(7 mc. phone)

VV5AM; X1BC; X1C; X1HH.

(14 mc. phone)

W 1ZD; 2BSD; 2EDW; 2UK; 4DBC; 4DQD; 8DQN; 9ARK;
9BJ; 9PSD. — C060M; C08YB; F8DR; G5ML; G5NI; HCL1G;
H15X; H17G; KA1AN; KA1AP; VP9R; VSGAF; YN10P.

(7 mc.)

CM2IP; CN8MF; CT1DT; CT1EG; CT1EG; CT1FZ; CT1LZ;
CT1LZ; CT2AJ. — D4 DNC; IXA; JZ1; KGH; LIM; NXR; OY;
TKP; UUP; UYD. — EA 1AW; 1BR; 2BH; 2BM; 2BS; 2BU;
3AV; 3BM; 3EG; 3EV; 4AB; 4BU; 5BD; 5BG; 5BM; 5CG;
7BE; 7BG; 8AC; 8AE. — F 3AD; 3EB; 3EG; 3KH; 8DC; 8DW;
8FO; 8GR; 8KJ; 8MU; 8NC; 8NU; 8NV; 8PQ; 8RU; 8VP; 8WK;
8X. — FB8AD; G5GQ; G5TP; G6BQ; G6CJ; G6DX; HAF5C;
HB9AC; HB9AT; HB9AY; HB9BC; HB9BK; HB9Y; I4ANL;
K4AAN; KA9JU; LY1S; OE3AH; OK1AQ; OK2AK; OK3MB;
ON4D0A; ON4UF; OZ7IM; PAOHB; PAOKW; PAOLR; PAOVB;
PAOXP; PK6AK. — SP1 AU; BB; CO; DN; DQ; DT; DY;
FI; GA; HA; HM; HN; HP; HZ; IA; IK; IT. — SU1KG;
SUITM. — U 2AU; 3CY; 3DM; 3DZ; 4LD; 5AH; 6WB; 8UX;

9AV; 9AY; 9AZ; 9MF. — UK3VA; VQ8AB; VQ8AF; VQ8AG;
VU2DB; VU6KH; XU9EC; XU8RL; YR5NP.

(14 mc.)

CM2AN; CT1CB; CT1JS; CT10I; D4BUR. — EA 1BC; 1BU;
3CY; 4A0; 4AV; 4AW; 4BM; 5AS; 5BD; 7A0. — E57C; F3LE;
F8BS; F8E0; F8GR; F8KE; G2BY; G2IM; G5IS; G6AG; G6BS;
G6OT; G6QX; G6VP; HB9AT; HB9AY; 1I1T; KA1DD; OA4AA;
OA4AG; OK1BC; ON4CH; ON4FE; PAOMG; PAOSE; PAOTB;
PAOUN; PK2K0; SP1BC; SU1RO; SU1WM; SU5NK; U2A0;
VE1EP; VP5JB; VS4AC; VS6AX; VS7JW; VU2EB; VU2EP;
VU7FY; XU8CB; ZB1H; ZP2AC; ZT6K; ZT6X.

W9DIB, Mitchellville, Iowa
To February 1, 1936

(14 mc.)

CM2AF; CM2BC; CM2D0; CM6RC; CP1AC; CX1CB; F88AG;
HC3AL; HJ3AJH; K5AH; K5AL; K7EA; LU1AD; LU1JH;
LU3HK; LU4F0; OA4M; OA4N; U2NC; VP1JR; VP1WB; VP2AT;
VP5AB; VP5JB; VP5MK; VU2CQ; XE2L.

Frank C. South, W3AIR, 2 Nassau Street,
Princeton, N.J.
January, 1936

(28 mc. only)

CM2FA; C060M; CPLAC; CT3AB; D4ARR; D4GWF; D4ORT;
D4QET; D4RVC; EA4A0; E15F; E18B; F8CT; F8KJ; F80L;
F8RQ; F8WK; FA8BG; G2HG; G2MW; G2PL; G2TM; G2YL;
G5B0; G5BY; G5FV; G5IS; G5LA; G5QY; G5VU; G5WZ; G6DH;
G6GS; G6IR; G6NF; G6QB; G6RB; G6RH; G6TT; G6WN;
G6WY; G6ZV; HAF8C; HB9J; HJ3AJH; LU9AX; OA4B; OE1FH;
OH5NG; OK1BC; ON4JB; ON4LX; ON4NC; OZ2M; PAOAZ;
PAOFX; T13WD; VK3BD; VK3BQ; VK3CP; VK3KX; VK3YP;
VK4AP; VP5PZ; XE1AA; XE1AG; XE1AY; XE1CM; XE2C;
XE2CG; YM4AA; ZS1H; ZS2A.

Harry G. Burnett, W1LZ, 16 Windsor Road,
Somerville, Mass.
January 26 to February 2, 1936

(28 mc. only)

CM2FA; CM2HC; CN8MQ; CP1AC; D4ORT; D4QET; EA4A0;
E18B; E15F; F8CT; F8R; F8WK; FA8BG; FA8IH; G2HG;
G2JH; G2NM; G2OA; G2PL; G5BY; G5FV; G5JW; G5UJ; G5QY;
G6AG; G6DH; G6GS; G6HL; G6LK; G6NF; G6QJ;
G6RH; G6TT; G6WY; G6ZV; HB9J; HJ3AJH; K4AOP; OA4B;
OE1FH; OK1BC; ON4JB; ON4LX; ON4NC; OZ2M; PAOAZ;
PAOFLX; PAOXD; SM6WL; VK3BQ; VK3YP; ZS2A.

Leonard Holmes, W9JGS, Wheaton, Illinois
February, 1936

(28 mc. only)

CM2FA; CM8AI; CP1AC; D4ARR; D4GWF; D4RVC; EA4A0;
E15F; E18B; F8CT; F8WK; FA8CR; G2HG; G5VU; G5UD;
G6DH; G6NF; G6RH; G6WY; G6ZV; HB9J; HJ3AJH; LU9AX;
OE1FH; OK1BC; OK3VA; OA4B; OA4J; OZ2M; SM6WL; VK3YP;
V04Y; V01N; VP5PZ; ZS2A.

C. J. Nolf, ON4NC, Chateau de Rameignies,
par Thumaide, (Hainaut), Belgique
January, 1936

(28 mc. phone)

W 1CGY; 1DBE; 1DZE; 1HVS; 1KH; 1NW; 2AIW; 2A0G;
2AYJ; 2BCR; 2CDL; 3AIR; 3AUC; 3FAR; 3PC; 3ZX; 4CJ;
7ALA; 8ANN; 8MWL; 8NK; 9BHT.

(28 mc. code)

CN8MQ; D4ARR; EA4A0; F8CT; G5FV; G6DH; G6LK; G6NF;
G6WY; LU9AX; OH3NG; OH5NG; OH7NB; OH7NC; OH7ND;
OH7NF; OH7NJ; OK1BC; PAOAZ; SU1JT; SU1RO; SU1SG;
VE3ER; VE3MJ; VE3FD; VE3WA; VK4EI; V01N; VU2BG. —
W 1AAK; 1AEP; 1ATD; 1ANA; 1BXC; 1CTW; 1DF; 1DHE;
1DUK; 1DXL; 1EHT; 1ELR; 1EWD; 1EWF; 1FH; 1GKX;
1HWP; 1IQZ; 1LZ; 1ME; 1RA; 1WV; 1ZE; 2ACY; 2AFF;
2AFU; 2AOL; 2AVZ; 2CPA; 2DFU; 2DTB; 2FBA; 2FF; 2GYL;
2GUX; 2HFM; 2SZ; 2UK; 3BIW; 3BPH; 3BRZ; 3BVE; 3BVN;
3BYF; 3BZB; 3CGU; 3CKT; 3DBX; 3EMM; 3ENX; 3EPR; 3HC;
3JM; 4AGP; 4AH; 4BP; 4BR; 4CCD; 4DAA; 4DCK;
4EF; 4MR; 4SV; 4TZ; 5AFX; 6BAM; 6WB.

DX



By **HERB. BECKER, W6QD**

Readers are invited to send monthly contributions for publication in these columns direct to Mr. Becker, 1117 West 45th Street, Los Angeles, California.

If this month's dx pages seem to be a washout . . . or maybe I should say, "more than usual" . . . please don't blame it altogether on me. By now you all should be aware of the fact that there has been a dx contest. You know, each fellow has been planning for weeks how he could out-fox the other guy, lying awake nights figuring out how he could make bigger and louder key clicks in order to put his local competition to bed. He'll try every kind of an antenna he can think of . . . orthodox sky-wires according to Hoyle and Hertz, and some wild ones of his own conception. He will spend weeks erecting some elaborate system that uses miles of wire, only to throw the thing out because he got R10 and not R12 from a VK. Then, too, there will be some fellows who will stick to just one simple antenna such as a single wire fed Hertz . . . which reminds me: Some cluck once told me that

absolutely the correct way to feed a single wire fed Hertz was to tap the feeder on right smack in the center of the flat-top . . . and I couldn't argue with him because he got louder reports than I did.

The gang will test out various frequencies either trying to get out from under some other fellow or trying to plop on top of him . . . all according to their relative power . . . but of course, none would ever think of increasing power for the contest . . . no, not much. To some it will be a lot of fun . . . to others a matter of serious business. Then other hams will consider it a "dog fight". But after it's over everyone will have that good ol' relaxed feeling . . . along with possibly a headache . . . and a few other aches.

Now, inasmuch as this is supposed to be dx news we might as well get down to business. From England comes word that G2ZQ has had varied experiences during the past few weeks: He heard XE1N on 7 mc. . . . PZ1AA on 1.4 mc. . . . and in his own words, "heard W6GRL CQing on 7 mc. one evening; no echo or anything—2200 g.m.t." The unusual thing is that the time was 2 p.m., p.s.t. . . . and that's something for a W6 to be heard at that time of day, as well as it is for a G to hear 'em at that time. G2ZQ got up on 3.5 mc. a while back with about 180 watts going into his T61D locked final. First contact was VE1EA for TBTOC . . . next evening an R7 from VK3EG . . . which must have been a real thrill. During the RSGB Tests on this same band, W 1, 2, 3, 8, 9, and VE 1, 2, and 3 were worked, and a report received from W7BBE. I think he would surely appreciate any reports from W 4, 5, 6, and 7; VE 4 and 5 from this 80 meter band. Here's one on John . . . while razzing KA1KG on the power the KA's use . . . this KA comes back with . . . "the joke's on U OM as input here is ten watts." G2ZQ has got a YL op. . . . who is nearly w.a.c. in her own right. He says, "She sure has a pretty fist

[Continued on Page 84]

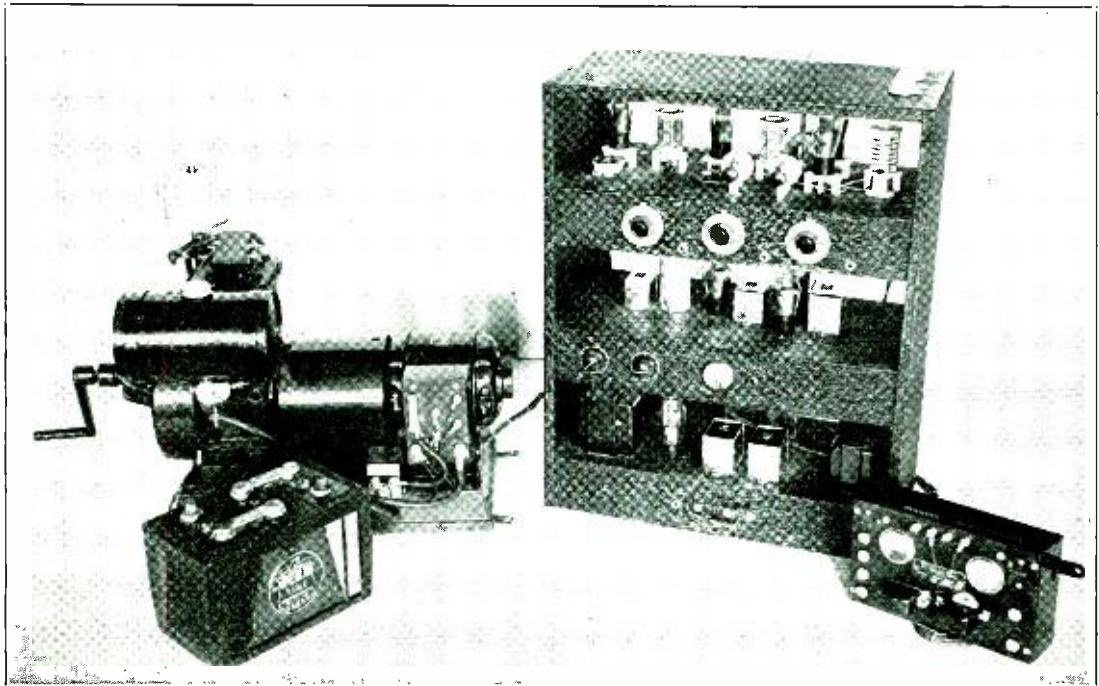

The New Transmitter and Power Plant Presented to ON4CSL by Friends in U.S.A.



The Reverend Carroll R. Stegall, ON4CSL, preaching in the native tongue to members of the Bakete tribe in the Belgian Congo.

ON4CSL

Amateur radio has a very important niche in the life of the Rev. Stegall. Carroll, as he is known to the hams, is a Presbyterian Missionary. His "home" is Chattanooga, Tennessee. He is a graduate of Georgia Tech, and has been in Belgian Congo for some twenty years, with the exception of an occasional furlough to the States. ON4CSL came on the air in the latter part of 1933 and since has made many friends. The rig that he has used in the past consisted of a single 210, and the receiver, an SW-3. A short time ago the New York Club of the Georgia Tech Alumni made him a gift of an FB7A receiver.

A movement to supply Carroll with a better outfit was started by Mr. Walter C. Johnson, Vice-president of the Chattanooga *News*, working through the Layman's Club of the First Presbyterian Church. With the help of W4AM, W4IB, W8JK, W4CRE, and a number of Chattanooga hams, a fund was raised sufficient to build the new rig shown in the photograph. The actual building of the outfit was taken care of by Billy Van Dyke, W4IB, with the assistance of Marvin Roddey, W4AM. John Kraus, W8JK, has had a weekly sked with ON4CSL for two years now.

The new rig has p.p. 210's in the final stage, and can be used on 'phone as well as for code. A Kato gasoline driven, 450 watt, 110 volt a.c.

generator complete with a starting battery is part of the equipment. The power for his old rig was from a dynamotor set which ran from a 24 volt Edison storage battery system. This

[Continued on Page 75]

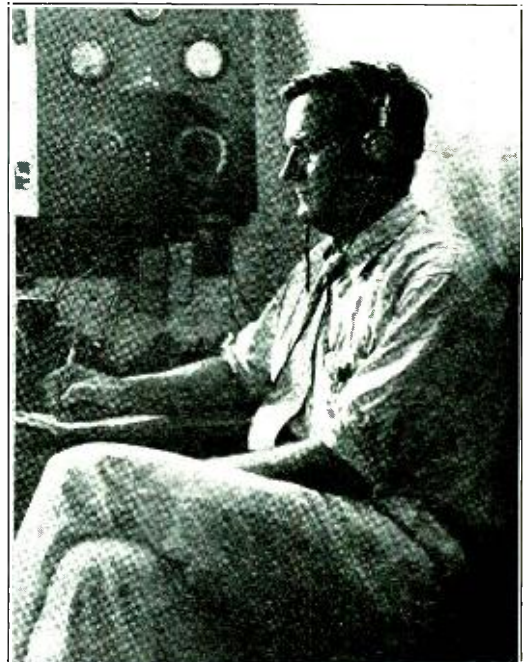

ON4CSL at the Key of His Former Transmitter



Remote Controlled Band Switching

By GRANT CORBY, W6CIN

Due to the rather unusual skip distance effects now observed on both the medium and high frequencies, it is desirable to be able to take advantage of good conditions on any particular band by being able to change from one band to another as rapidly as possible. As the writ-

"Listen for me on ten," requests W6CIN. And unless you can switch bands on your receiver in nothing flat, you will find that Corby has been calling you for some seconds by the time you get your receiver cranked up on that band. We prevailed on him to describe for our readers his 1 kw. phone transmitter that operates on 10, 20, or 75 meters with instantaneous band selection, remote controlled.

ately more change in frequency is allowable before returning of any tank becomes necessary.

The circuit diagram of the radio frequency portion of the transmitter is shown in simplified form. Everything is standard practice except for the switches and a few wrinkles described later.

The crystal oscillator uses an RK23 pentode in the tritet circuit. A 160 meter crystal is used for 75 meter operation and a 40 meter crystal serves for 20 and 10 meter operation. Thus the oscillator is always doubling in its plate circuit. Sw₁ selects the desired crystal and switches 2 to 11, which operate together, select the desired tank circuit for each amplifier stage.

Sw₃ selects the plate tank for the RK23 and Sw₄ cuts in the extra 841 doubler, which is used only on 10 meters. The RK20 buffer stage always amplifies straight through on the same frequency as the 860's and the final amplifier. Sw₅ selects the plate tank for the RK20. These tanks are not split; so link coupling is used to the split grid tanks for the push-pull 860 driver stage. Sw₆ and Sw₇ switch the 860 grids to the desired grid tank and Sw₈ and Sw₉ choose the plate tank for the 860 stage as well as the grids of the 251A's. Sw₁₀ and Sw₁₁ switch the plates of the final amplifier to the proper tank and antenna circuit. The split tanks all use split-stator condensers, and the neutralization of the final stage is not disturbed as the bands are changed.

A great deal of attention was paid to locating the various tank circuits so that excessive stray coupling would not be present. The final amplifier is completely shielded from all the other stages; and the RK23, 841 and RK20 stages are all shielded from the final stage and from each other by aluminum cabinet construction.

The ganged band-change switches are operated manually at the present time but two old phonograph motors are being set up to allow complete electrical control in the near future.

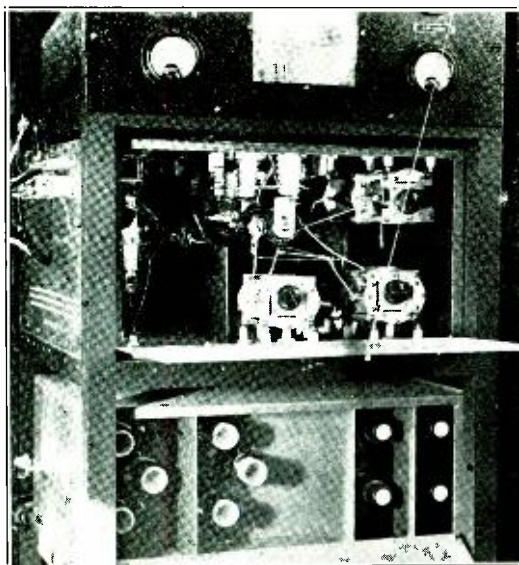

The heart of the remote-control band switching system used at W6CIN

er's amateur activities are almost entirely devoted to phone, the three dx phone bands were chosen for this transmitter. In addition to the remote controlled band change feature, the use of six crystals allows the rapid change to any one of three frequencies in each phone band. This feature is a great advantage in avoiding QRM, as it is possible to QSY either slightly up or down in frequency from the main operating frequency in order to get away from a bad heterodyne. Tuned circuits in the average transmitter are not extremely selective, and frequency changes of 10 kc. on the m.c. band require no retuning of the various tank circuits. On the higher frequencies, proportion-

**"Jug Department"
W6CIN**

In the foreground are the two 849's which act as modulators (class AB). Peeking from behind may be seen the 251A's of the final r.f. amplifier. These operate in push-pull, class C, on the 10, 20, and 75 meter bands with instantaneous changeover.

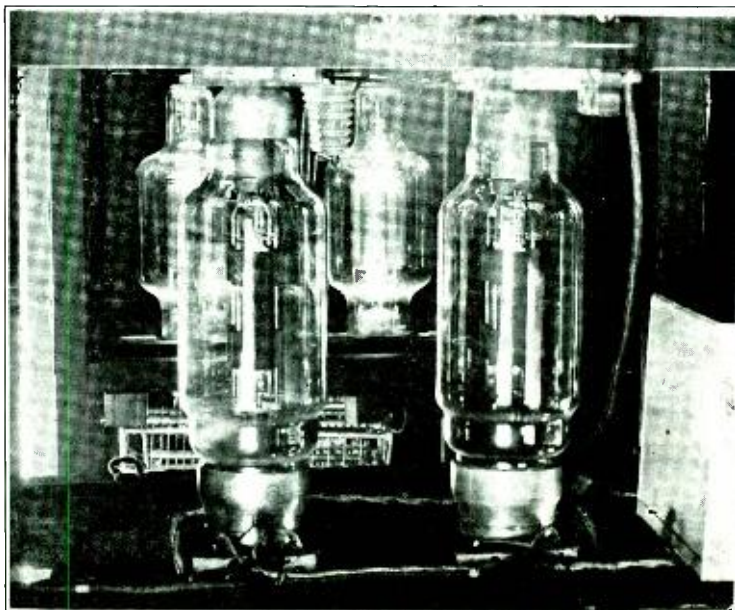

As the transmitter uses a metal front panel it was considered desirable to place all the grid and plate milliammeters in the grounded leg of the plate and bias supplies. This is not as simple as it sounds if it is desired to have each meter read only the grid *or* plate current and not both. However, it was solved by a combination of ungrounded bias and plate power supplies, in each case grounding the power supply through a meter. It also required thought to avoid having one meter read currents to more than one stage. In some stages the grid meter is between filament center tap and ground, in which case the negative B lead must be ungrounded and the d.c. plate return completed *above* the grid meter. In the next stage this procedure is reversed. The plate milliammeter is in the cathode-to-ground circuit and the positive bias connection is ungrounded and goes back to filament *above* the plate milliammeter. This may sound a little complicated but is necessary when it is essential to keep all meters at approximate ground potential.

The 841 doubler is used only on 10 meters and it draws 50 m.a. of plate current.

A block diagram of the audio channel used at W6CIN to modulate the transmitter is shown. Two mikes are provided, but the crystal microphone is used most of the time. The audio channel is standard practice throughout and the 849's run as class AB modulators

at 2000 volts. The resting plate current on the 849's is 200 m.a. Separate 2000 volt power supplies are used for the modulator and final amplifier, and the d.c. to the final amplifier is shunt-fed through a modulation choke and does not flow through the oversize class B output transformer.

The following table shows the various operating grid and plate currents on the three bands.

Band	RK23		RK20		860's		251A's	
	Plate	Current	Grid	Plate	Grid	Plate	Grid	Plate
75 m.	60 ma.		10	90	50	250	150	500
20	60		10	90	45	250	150	500
10	60		10	110	20	250	90	500

As the circuit diagram shown of the transmitter is somewhat simplified, not all of the various r.f. chokes and by-pass condensers are shown that are actually used to improve the circuit isolation. These chokes and condensers are not always necessary and their use depends largely on the mechanical layout of the transmitter. All the essential chokes and condensers that must be used in any case are shown.

The rig works perfectly and the pleasure of being able to come back to a call on any of three bands in the fraction of a second re-

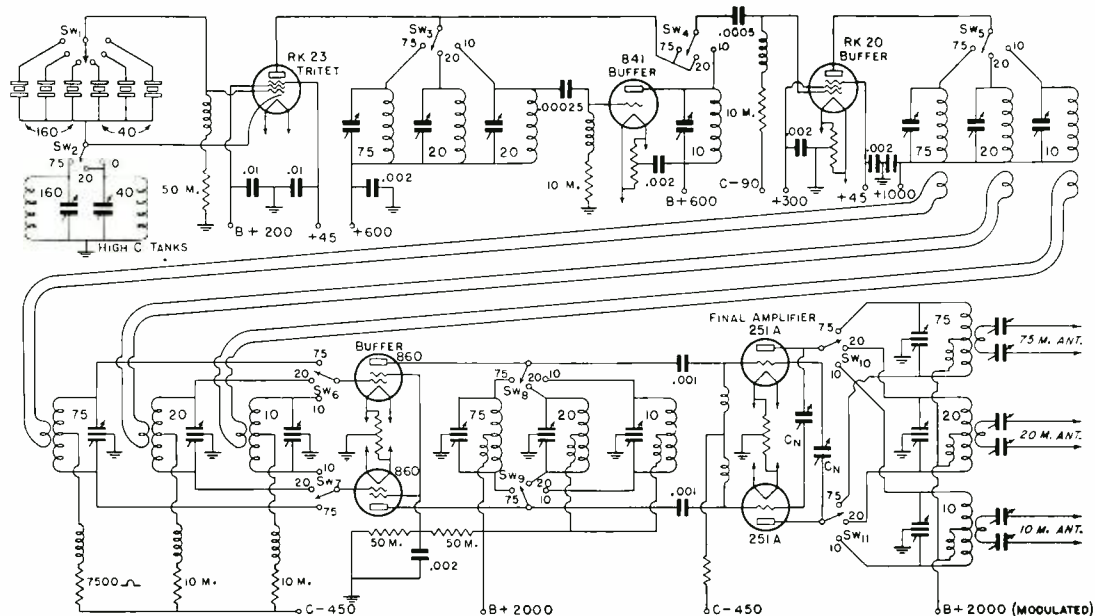

ABOVE
Simplified Schematic of the R.F. Portion of
the W6CIN Transmitter

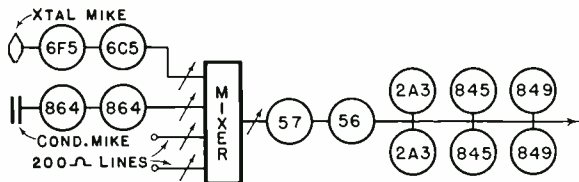

LEFT
Block Diagram of the Speech Channel

quired for the coil switches to rotate is impossible to describe. Everyone who has operated this transmitter swears that all of his own future transmitters will incorporate instantaneous band switching.

Liquid Microfarads

We have at hand a communication from Scratchi, our faithful correspondent and kibitzer, informing us that he has done very little b.c.l. listening of late, because all he can get on the local Osockme station is one selection, "The Songs Go Back and Forth and Come Out There," he complains.

In the same letter he bemoans a beautiful black eye, a result of engaging in fisticuffs with a friend with whom he became involved in an argument. The argument ensued when his friend, who is a manufacturer of synthetic Saki brandy, 201 proof, referred to Scratchi's copper tube 80 meter inductance as a "condenser". Quoting from his letter:

"I try to explain my shoelegger friend that mayhap such coppers tubing are condenser to

him but proper radio term are 'inductance', as condenser are having capacity instead of millionhenries. My pal say sure the coil have capacity; he are have one same number of turns home and have capacity of 3 quarts per hours, when tubing are kept dunk in ice. Scratchi decide only arguments that avail with such ignorance person are five fingered argument, in which Scratchi unfortunately use eye to hit other gentleman in the fist."

To Clean Copper

Prepare a strong soda or potash lye solution by adding about a pound of lye to a pail of boiling water. Dip the metal or apply this solution with a brush, scrubbing well. Then rinse or wash with plain hot water and finally with cold water.—W6DOB.

Weston informs us that their Model 588 direct-reading percentage modulation meter is no longer manufactured.

New York state has the most radios, with Pennsylvania running close behind.



A Dual-Frequency Crystal Calibrator

Frankly, we did not at first feel very cordial toward the TMV-133A crystal calibrator. It looked like another serviceman's "gadget". For another thing, the first information on it arrived in the form of a printed story in another publication. This always reduces any good magazine man's temperature below the frost-line. He has to be sold, after that happens.

So when a sample arrived from Camden for trial there was no enthusiasm, even though the extreme value of a crystal calibrator was thoroughly appreciated long before this. But after living with the TMV-133A as long as was decent before sending it back to Camden, we had an altogether different view of the device.

Where It is Different

The TMV-133A has as its main distinction a trick crystal which can oscillate at either 100 kc. or 100 kc., thus making available two complete families of harmonics. One family starts at 100 kc. and is spaced 100 kc. apart at 200, 300, 400, etc. right on up to 20,000 kc. or more. This gives a fine lot of calibration points. In fact they are so close together that it is easy to get the wrong one by the tail when making a first calibration or spotting points on a receiver dial. This is where the second frequency comes in. By merely flipping a switch to "Hi" the oscillator jumps to 1000 kc. and gives a point there, with harmonics at 2000, 3000, 4000, 5000, 6000 and so on right on up to 50,000 kc. and beyond. Another nice, though not exclusive, feature is a provision for using either a.c. or d.c. plate supply for the 955 acorn triode which serves as the oscillator. There are three binding posts. When a c.w. signal is wanted a 45 volt B battery is connected between the two outside posts. When a modulated signal is wanted the battery is removed and the "+" post is connected to a center binding post, which connects the a.c. line to the plate-supply lead.

Receiver Use

Anyone who has ever used a monitor or other tunable oscillator to spot frequency points on a receiver knows how easy it is to become uncertain whether one has the right harmonic or not. The double set of harmonics at once



The Piezo-Electric Calibrator

removes this doubt. For instance, suppose we are trying to locate 3200 kc. If we have only the 100 kc. oscillator it is easy to become uncertain whether an unfamiliar receiver is at the wanted frequency or whether one has the wrong harmonic. With the TMV-133A this is simple. By merely flipping the switch to "Hi" we set up the other system of harmonics, one of which is sure to be 3000 and another at 4000 kc. Locating these, one flips the switch back to "Lo" and "counts birdies," allowing 100 kc. each. Now we know which harmonic we have. In almost any

combination these cross-checks are possible in one way or another.

Suppose we have an all-wave broadcast receiver one scale of which is known to be off. Suppose we wish to recalibrate the range of 8 mc. to 20 mc., which is to say 8,000 to 20,000 kc. High accuracy not being useful, for convenience we shift the TMV-133A to the a.c. plate connection and quickly spot 13 points 1000 kc. apart by using the oscillator on the "Hi" 1000 kc. point. There are always enough stations around so there can be no chance of being off by as much as 1000 kc. Then if desired the switch is shifted to "Lo" and the additional points are "spotted in" 100 kc. apart. The result is a calibration amply good for an all-wave receiver. By trial it takes about 10 minutes. With a tunable oscillator it has always taken longer and been much more careful business. With a single-frequency crystal oscillator there has always been one of two difficulties. If the frequency was around 1000 kc. one had points rather far apart and needed to fill in with another tunable oscillator with a fair calibration. On the other hand if the crystal rig oscillated near 100 kc. one had to make a rough preliminary calibration against known stations or a calibrated plain oscillator so as not to get off one harmonic on a strange receiver. Don't say such accidents cannot happen—they have happened in the laboratories of the most careful outfit in this country (no, not meaning ours!).

Amateur Band Spotting

About 17 frequency points will outline all the amateur bands for which this oscillator is

[Continued on Page 82]



"But Not for Voice"

By ROBERT S. KRUSE

"These 'phone guys can't hear anything without a super," said a c.w. operator at a recent club meeting. It has been said many times before, in different ways.

Offhand it does seem as if a c.w. man's ability to do good long-range work with a 3 or 4 tube receiver may indicate that he is very bright or skillful. I'm inclined to think that on the average he is both.

However the voice man is not stupid. On the contrary the top-flight 'phone man knows as much about the use of his equipment as anyone in the game, and there is more of it. He has good ears and between them a set of good brains in daily use.

Two Kinds of Sensitivity

The receiver, however, is a great deal "dumber" for voice than for c.w. This is our story and a brief one it is.

Suppose we start with the family of simple receivers which are descended from the old Browning-Drake receiver. You've all used them under various names: Pilot Super-Wasp, National SW-5 and SW-3, the "Diamond of the Air," and a lot of others.

Short-circuit the tickler coil of any one of them and it is as dull as mud. In the 80 meter band one must pour into it a terrible signal before standard output results. Anything from 500 microvolts to 2000 microvolts is required; that's $\frac{1}{2}$ volt to 2 volts and will wreck a modern receiver's loudspeaker.

With the short removed from the tickler and the detector regeneration put into use, things look better as to sensitivity, but also there begins to appear the difference between c.w. and voice performance.

If the regeneration is advanced to the point where one can barely hear distortion on a high-quality musical signal, the sensitivity has improved so much that an input-signal of only 100 microvolts will produce standard output.

Advancing regeneration still further, to the edge of actual oscillation, we find very decent sensitivity indeed, only 5 to 20 microvolts (depending on the particular receiver tested) now being needed to produce standard output. This compares pretty well (at 80 meters) with some superheterodynes of tolerably recent design.

Of course the noise is now bad, as is the distortion.

Running the regeneration still higher, into the region of actual oscillation, we find the noise to go down abruptly, while the sensitivity rises still further, so that direct comparison with even present-day superhets, on c.w. signals, is not very damaging to the simple set. Which of the sets is the noisier depends on the individual set chosen, the kind of noise we are dealing with, and the signal level; so that any general answer is probably hasty or opinionated.

Strong-signal Selectivity

Thus the simple set gave a much better account of itself for c.w. than it did for voice, when sensitivity is considered, removing suspicion as to defects of the 'phone man's ears or brain.

On top of this there is the matter of interference. The simple regenerative receiver has a weak-signal selectivity which is very impressive for so simple a gadget; but alas, its strong-signal selectivity is very poor. There are other ways of saying the same thing. One can say that strong off-tune signals break through the selectivity of the regenerative receiver, though weak ones do not; or one can say that the selectivity curve has a very sharp peak but very wide flaring skirts. But it all means that in an amateur band full of phones the thing is out of luck.

The superheterodyne has more selectivity for two reasons, the simpler of which is that it uses more tuned circuits. If we count both the tunable r.f. circuits and the fixed-tune i.f. circuits, there are 5 to 9, against the 2 tuned circuits of the simpler receiver. In addition to this there is a selectivity gain in the process of converting a signal to the (lower) i.f. frequency. The contrast is a very severe one.

This is altogether apart from the use of crystals as "tuned circuits" in an i.f. amplifier. This device, available to the super but not to the t.r.f. receiver, still further increases the discrepancy in selectivity, and suppresses noise. Whether these gains are enough to pay for the accompanying defects is a matter of personal opinion. The difficulties produced by a crystal filter are: oftentimes a decrease of sensitivity,



a tendency to put "tails" on telegraphic dots and dashes, and a quite horrible distortion of voice signals. The latter can be corrected in a large measure and very easily in the audio system, and this was done in the original crystal-filter super, the one of Robinson, called the "Stenode". It is only fair to point out that the application of a similar correcting-audio-system is not practical for the regenerative receiver as it will there produce a quite overwhelming amount of high-pitched noise.

HAM HINTS

By JAYENAY

Getting a Pure D.C. Note

No two amateurs seem to agree on how much power supply filter is necessary or desirable in a c.w. transmitter. One cause of this difference in opinion lies in the way the final amplifier is operated. If a class C r.f. amplifier is very heavily excited by its driver stage; or, in other words, is being operated as a high efficiency amplifier, most of the hum modulation present in the output of the preceding driver stages is wiped off by the non-linearity of the final. Under such conditions the oscillator and buffer stages require but little hum filtering in their plate power supplies. However, heavily exciting the final makes it particularly sensitive to ripple in the plate supply to the final itself. On the other hand, if the final stage is operated with rather low grid excitation, less filtering in the final plate supply is necessary, although the oscillator and buffer stages will require more filtering to keep the note p.d.c. Also, if the final stage is not perfectly neutralized, any hum from the final power supply will be somewhat emphasized.

In a few cases, operators have successfully utilized an excess of residual hum from a separate bias pack for the final amplifier to partially "buck-out" the hum produced by the plate supply to the final. Careful adjustment of the filter on the bias pack often allows a marked reduction in the carrier ripple. However, due to peculiar ripple wave forms in some cases, particularly where resonance or near resonance exists in the filter circuits, this method of hum bucking only makes the note worse.

Parasitic Oscillations

Many phone transmitters are troubled with a bad parasitic located from 10 to 200 kc. each side of the carrier. This parasitic is usually a bad r.a.c. note which disappears when the

carrier is modulated.

This particular form of parasitic is very hard to locate due to the fact that no matter how much special filtering and damping is applied to the buffers and final amplifier, the parasitic still is with us.

Whenever a parasitic is found located the same number of kc. above and below the carrier frequency it usually will be found to be coming from the audio channel. In most cases it will be found that the modulators are oscillating at from 10 to 200 kc. and this low frequency oscillation is then modulating the carrier in the normal manner. First check the source of the parasitic by cutting off the plate voltage to the modulators and see if the parasitic disappears from the carrier. If it does the audio channel is at fault and the parasitic can be eliminated by either of two remedies. The best way to eliminate *any* parasitic is to detune the parasitic circuit so that oscillation can not be maintained. Try shunting a small condenser from grid to grid or else from plate to plate of the modulators (assuming push-pull modulators are used).

If the parasitic resists this treatment, then damping resistors will have to be used. The objection to damping resistors is that they will waste some audio power. However, the waste is small. Try 50 to 200 ohms in series with one or both grid leads to the modulator. After that try 50 to 200 ohms in series with each plate lead. Incidentally, it is a good idea to keep at least 50 ohms in series with each plate lead in any class B modulator in order to cut down the occasional bad current surges due to switching or dropping the mike, etc., which can cause a tube failure if the tubes are not protected against such surges.

After trying series damping resistors try 5,000 to 50,000 ohms shunted from grid to grid or from plate to plate.

The high μ and zero bias class B modulators are particularly susceptible to this type of parasitic. Changes in tubes and bias also sometimes eliminate this type of parasitic.

A man was arrested in New York many years ago on an extortion charge when he claimed an invention which would convey the human voice over wires by means of electricity. In comment, a Boston paper said that well-informed people knew the thing could not be done; and even if it could, that it would be of no practical value.



Simple Volume Range Expansion

By JAYENAY

Due to the fact that the range of sound that can be handled by audio amplifiers used for recording and in broadcast is limited, manual monitoring is used to reduce the volume range of symphonic and dramatic presentations from

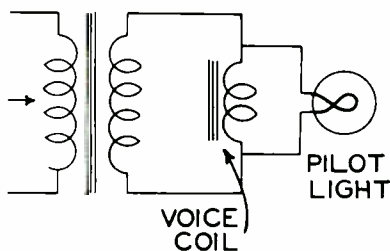

Figure 1

the normal range of about 55 to 60 db down to 35 db or less. This cuts down the peaks of volume and raises the weak passages. The limits of volume range in broadcasting and recording are set by ground noise, which includes tube hiss and hum at the low end, and distortion or overmodulation at the upper end.

In an attempt to correct slightly for this volume range compression which now occurs on all recordings and broadcast programs, both R.C.A. and Crosley have developed means for expanding the volume range of the program material at the reproducing point. Also, it can be expected that when volume range expansion becomes common in receivers, automatic volume range compression will be added to all broadcast transmitters in order to improve the received signal to noise ratio. The first workable volume range expander was shown by Hisserich and McProud in *RADIO* for May, 1935. The R.C.A. expander circuit is quite similar.

The Crosley expander circuit is considerably simpler than any shown yet and operates by reason of the fact that the resistance of a tungsten filament goes down as the temperature of the tungsten is raised. Thus, as more current passes through the tungsten, its resistance increases. The simplest volume range expander based on this principle is shown in figure 1. An ordinary tungsten filament pilot light is shunted across the voice coil of a loud speaker.

At low levels the filament is cold and

acts as a low resistance short across the voice coil, bypassing most of the audio around the speaker. As the audio volume is raised, the pilot light warms up and its resistance rises, forcing a larger proportion of the total audio signal to actuate the loud speaker. Thus the audio output of the speaker goes up faster than the increase in audio signal. The range of volume expansion of this method is limited; so the simplified version of the Crosley system shown in figure 2 is more desirable.

Here the resistance variations of the two tungsten filament globes are magnified by the bridge arrangement in order to extend the range of control. The resistance of R_1 and R_2 are constant at one ohm. The resistance of the two lights L_1 and L_2 vary with the audio current passing through them, and the stronger the audio signal, the higher the resistance of the lights, and the more the bridge is unbalanced, placing more of the available signal across the voice coil winding.

Some audio power is wasted in the resistors R_1 and R_2 , as well as in the lamps, but audio power in a receiver is relatively cheap and a small loss is not important.

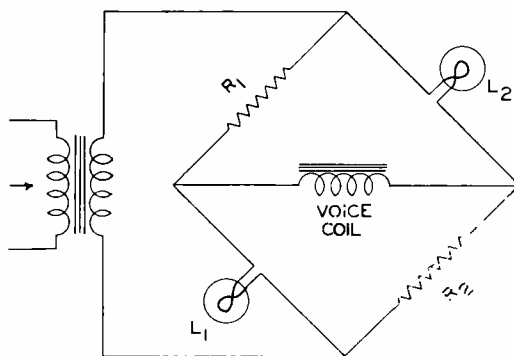

Figure 2

No measurable amplitude distortion is caused by this method of volume range expansion due to the thermal inertia of the filaments in the lamps. If the change in resistance could occur several hundred times a second, appreciable distortion would be produced, but as the thermal inertia damps out any changes over about 20 cycles per second, only the syllabic changes in audio amplitude affect the expander.



The actual Crosley circuit is shown in figure 3 and is the same as that of figure 2 except for the equalizing transformer T_2 , added as shown. The two primaries buck each other so that there is no current in the bypassed secondary winding as long as the current through the two lamps L_1 and L_2 is equal. As the two primaries buck each other, there is little inductance added to the bridge circuit as long as there is no unbalance in the system.

This suggests a new idea for applying controlled carrier operation to a transmitter. If it works you will hear about it in an early issue.

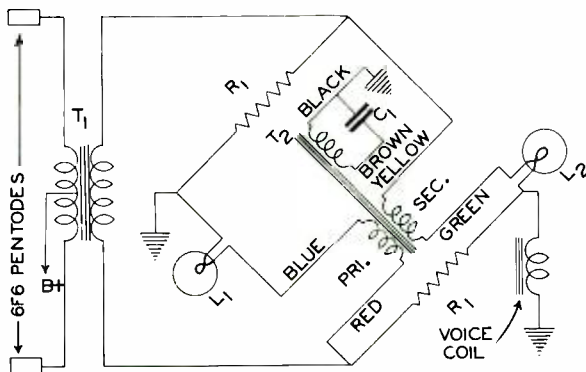

Figure 3

◆
If you don't get enough grid drive in an amplifier, try reversing the link connections. Sometimes it is better to have stray coupling aiding, rather than bucking.—*W9FM*.

◆
Does your 59 tri-tet crystal oscillator drift badly? Try reducing the screen voltage to 50, then run the plate up to 400.

RADIOODDITIES

Where to Find 'Em

W9HRP on a county fair lot . . . W1HWZ in a department store . . . W2BSN on Walnut St. in Nutley, N.J. . . . WAR at the Army headquarters in Washington . . . ZEP at an East African airport.

Radio in World War

The station on Sayville, Long Island, which was shut down after being caught transmitting unneutral messages at the beginning of the War, was the same outfit which only a short time previous put through the first QSO between the U.S. and Germany, a message from President Wilson—"President to Kaiser, Congratulations, Trust in increase of amity." A ham's alertness was responsible for the apprehension of the station. Charles E. Apgar recorded the fateful messages on phonograph records which are now preserved at Radio City in New York. . . . An all-district U.S. 'phone hookup was effected in forty-five minutes without previous arrangements. . . . Six-year old Elmer Pendleton of Columbus, O. could send the code at eight words a minute before he started to school! . . . Few knew that Z. Smith Reynolds, murdered millionaire husband of Libby Holman, was an active ham. . . . A magnetic speaker was apt to cost thirty dollars or so in 1925.

HINTS AND KINKS

By W6DOB

To Resharpen Old Files

Wash the files in warm potash water to remove the grease and dirt, then wash in warm water and dry by heat. Put one and one-half pints warm water in a wooden vessel, put in the files, add three ounces blue vitriol finely powdered, three ounces borax. Mix well and turn the files so that every one may come in contact with the mixture. Add ten and one-half ounces sulphuric acid and one-half ounce cider vinegar. Remove the files after a short time, dry, rub with olive oil, wrap in porous paper. Coarse files should be kept in the mixture for a longer time than fine ones.

To Give Brass a Dull Finish

Mix one part (by weight) of iron rust, one part white arsenic, and twelve parts hydrochloric acid. Clean the brass thoroughly and apply with a brush until the desired color is obtained, after which it should be oiled, dried, and lacquered.

Screw Lubricant

Put hard soap on lag screws, wood screws, or any screw for wood. It will surprise you how much easier they will turn in, and prevent or at least reduce splitting.

Polish for Bakelite and Crackle Finish

Mix two parts benzine with one part mineral oil and apply with cloth. Wipe with dry cloth. This is not a messy polish and does not leave an oily surface.

◆
The alpha and omega of broadcasting, WABC and WXYZ, are located in New York and Detroit respectively.



An Effective, Inexpensive Keying Monitor

By WILLIAM F. JACKSON*

The purpose of this paper is to describe a simple and effective method of monitoring one's sending without building up any shielded receiving circuits or cutting into the station's receiver. The method can be used

If more amateurs would use a keying monitor, not only when using a "bug" but also when using a straight key, there would be a great improvement in the "fists" heard on the air. One can never learn good sending without listening to one's own fist, and even after a good fist has been cultivated a keying tone is necessary if one wishes to retain it. Have you listened to your fist lately? You may be surprised!

ingly "below" the key we connect in a resistor R_1 having a resistance of 500 ohms. The grid current flows through this and

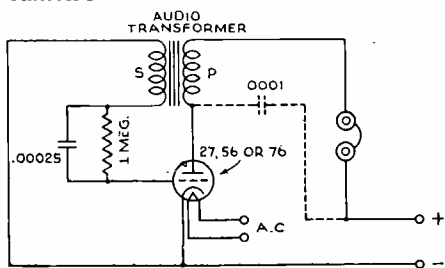

FIGURE 1

at any code station, and is entirely free of any fussy adjustments. The parts are few and cheap.

The idea of this type of keying monitor is to listen to an audio-frequency oscillator instead of listening to the transmitter itself. This oscillator "follows" the keying of the transmitter because its plate supply is "borrowed" from the transmitter in such a manner that there is no oscillator plate voltage except when the key is down. It is not necessary to take off much voltage, nor is it necessary to use any relays or other complications. The simple oscillator shown in figure 1 functions perfectly with a very low plate voltage; even 2 volts will do the trick when using a 27, 56 or 76 tube, but about 5 volts is better, and the current required remains extremely small.

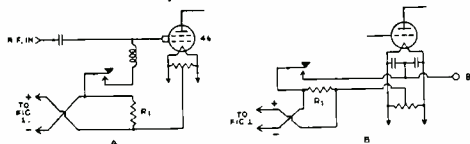

FIGURE 2

How to Borrow 5 Volts

In figure 2a we have a type 46 (zero bias) tube being keyed by opening the gridleak (not a safe scheme for other tubes except the 838). Suppose we measure the grid current with a d.c. meter and find it to be 10 ma. Accord-

gives us:

$$500 \text{ ohms} \times 0.010 \text{ amp.} = 5 \text{ volts of d.c. drop}$$

There is one possible plate-supply for the audio oscillator-monitor.

In figure 2b we have a tube with center-tap keying. Bridging a d.c. meter across the key we find a current of 100 ma.; therefore R_1 in this case need be but 50 ohms to give us the necessary 5 volt drop. If in doubt use a resistor with a slider for adjustment.

In figure 3 we have other schemes for supplying plate power to the monitor-oscillator. At 3a a pickup coil (tuned if necessary) is used to take some r.f. from any convenient tuned circuit of the transmitter. This r.f. is fed to the audio oscillator, which must then have the condenser shown dotted in. The audio-monitor-oscillator tube acts as its own rectifier and gets

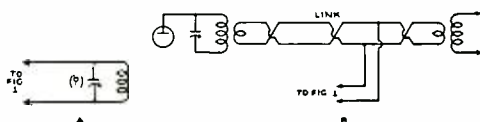

FIGURE 3

along very nicely with an r.f. plate supply; try it and see. Of course the pick-off coil must be coupled to some r.f. circuit that is "dead" when the key is up.

At 3b a link circuit has been tapped to supply r.f. to the audio tube.

Precautions

It is well to begin by trying the audio oscillator with a battery of approximately known voltage. Try different available tubes and audio transformers to get dependable operation, a pleasing tone, and as low a plate voltage as possible.

To eliminate switching the headset from the monitor to the receiver one may use a more powerful oscillator—which calls for more plate voltage of course—and feed a small magnetic loudspeaker. This is a great improvement, especially when using break-in.

[Continued on Page 75]

*W9EGF, 346 Iroquois St., Laurium, Michigan.

WHY SHOULDN'T YOU



A FELLOW HAM GREW SAD AND BLUE, BECAUSE HE WAS SO NERVOUS, HE SAID THAT IT ALL WAS DUE TO INEFFICIENT SERVICE.



HIS EXPERIMENTS TURNED SOUR, TRANSMISSION WAS VERY POOR, LIFE WAS NO BOWL OF CHERRIES, FOR THIS LUCKLESS AMACHOOR.



NOW HIS TROUBLES ARE FORGOTTEN, HIS WORK IS COMING SWELL --- AND THINGS ARE FAR FROM ROTTEN, SINCE HE HAS THIS TALE TO TELL...



" I BUY ALL MY 'HAM' SUPPLIES FROM WHOLESALE RADIO SERVICE... and they're the best in the business!"

USE THE ONE COMPANY THAT AMATEURS FIND "BEST-BY-TEST" —
WHOLESALE RADIO SERVICE CO., INC.



Why shouldn't you too rely on the one leader in ham equipment? No other company can equal our 16 years of leadership . . . our staff of 50 trained technicians . . . our lowest "Wholesale" prices . . . our huge stocks of ALL THE NATIONALLY KNOWN LINES . . . and our big 68 page exclusive amateur catalog!

Send for your copy today! This catalog lists everything in S.W. Equipment by all leading manufacturers and describes our convenient time-payment plan. Paste coupon on your Q S L card for a free copy!

WHOLESALE RADIO SERVICE CO.
 CHICAGO, ILL. • NEW YORK, N.Y. • ATLANTA, GA.
 901 W JACKSON BLVD • 100 SIXTH AVE. • 430 W PEACHTREE ST. N.W.
 BRONX, N.Y. • NEWARK, N.J.
 542 E FORDHAM RD. • 219 CENTRAL AV.

Wholesale Radio Service Co., Inc.
 901 W. Jackson Blvd. Dept. R-46
 Chicago, Illinois.
 Please send me Free Copy of exclusive Amateur Catalog.
 Name.....
 Address.....
 City..... State.....

A type 37 tube was operated continuously for twenty-two thousand hours in telephone carrier apparatus by the Ohio Public Service Co.

A network of tiny ultra-short wave stations keeps engineers in contact on the new San Francisco Bay bridge project.

Interstage Coupling

(Continued from Page 57)

cuit. Note that the coupling link should never have more than three turns at each end, regardless of frequency. Use as few turns as possible and note that the number of turns at each end of the coupling link may not necessarily be equal. In fact, the best way to vary the coupling ratio is to have more turns at one end of the link than at the other. The coupling links should always be coupled to the cold ends of the plate and grid tuned tanks in order to minimize capacitive coupling between the two tanks. Grounding the coupling link close to the plate circuit of the driver also cuts down this undesired coupling and tends to eliminate interlock between the tuning of the two stages. Link coupling is advantageous mainly because it allows grid and plate leads to the tubes to be short and direct, yet the link may be several feet in length where desired so that stakes need not be crowded together. The use of link coupling eliminates all r.f. chokes and also simplifies the driving of a push-pull stage from a single-ended stage. Note that a link coupled to a push-pull stage or a split neutralizing tank should still be coupled to the cold or ground r.f. point on the tank, whether it be at one end or in the center of the tank.

Interstage Coupler Adjustment

It is hoped that the reader has derived a few glimpses of light up to this point and has an understanding of what interstage couplers should do.

The adjustment of the coupling ratio will be simple if the following points are kept in mind.

If the grid resistance is reflected back through the coupler as too high a load resistance for the driver stage, the driver stage will not draw enough plate current. If the reflected grid resistance appears as too low a plate load resistance for the driver, the driver will draw too much plate current and will probably run hot. In other words, try a one-to-one coupling ratio first. If the driver plate current is too high, the r.f. voltage output of the driver will have to be stepped down by the coupler, which will reduce the driver plate ma. and may even *increase* the grid current on the driven stage, due to an increase in driver plate efficiency.

Save!



LOWER PRICE . . . HIGHER QUALITY



Mass production economies ploughed back into lower prices! Our regular labelled, voltage-rated, guaranteed, oil-filled transmitting condensers are now available at still lower prices. Compare these units with all others . . . in quality, features, costs. You no longer have to be content with unknown brands or orphans disclaimed by their own makers.

Compare Prices!

TYPE 1005 — 1000 V.			
Cap.	Old List	New List	Your Cost
1	3.20	2.70	1.62
2	4.25	3.35	2.01
4	6.00	4.85	2.91
TYPE 1505 — 1500 V.			
1	4.00	2.85	1.71
2	5.25	3.90	2.34
TYPE 2005 — 2000 V.			
1	4.75	3.55	2.13
2	6.50	4.75	2.85

Sturdy cans . hermetic sealing . . . seepage-proof.

Pure paper dielectric . . . oil-impregnated . . . oil-filled.

Genuine high-tension pillar insulator terminals.

Conservative ratings . . . cool operation . . . longest life.

Positively the best value ever offered. Quality condensers at bargain prices. Only popular acceptance makes these new prices possible.

DATA Send for new 1936 catalog covering condensers and resistors. Also sample copy of Research Worker.

AEROVOX

CORPORATION

73 Washington Street

Brooklyn, New York

BUY IT ON TIME

DO YOU WANT YOUR NEW RECEIVER NOW? Buy it the easy way on our really "Low Payment" Plan.

Write quickly for complete details.

HINDS & EDGARTON

19 S. Wells Street Chicago, Illinois
(Est. 1914 — Management by W9APY-W9WR)



ON4CSL

[Continued from Page 63]

same battery system is used at the Hospital, where Carroll's station is located, for lighting purposes. The batteries are charged by a wood-burning steam engine, driving a generator.

It is really marvelous the way folks have operated to make this new transmitter possible for the Rev. Stegall, and putting it into his own words, "It has simply sprung from nothing but prayer and faith. I have never asked a soul for a centime."

The heavy QRN in the Congo makes it very difficult to work on higher wavelengths than 20 meters. Thunderstorms are numerous and very severe, and on at least one occasion ON4CSL received quite a shock from lightning which struck nearby. While QSO with W4AM recently, Carroll was actually interrupted by an attack on his "shack" by driver ants. Some time ago he built a windmill for the purpose of running the generator to charge batteries. It was an 8 blader, each blade 4 feet long. Four blades were of wood and the alternate ones

were of iron. Says ON4CSL, "Did that mill fly? Recently a real blow hit us. I had not figured on the centrifugal force. Well sir, that mill blew all to pieces; two of the iron blades went clear over our house and fell in the mango trees in the front yard. A third went in the opposite direction and fell in a cassava field. I looked for the fourth in vain. Several days later a native brought it in. I don't know where he found it."

This will give a small idea of what one has to put up with in the tropics, and at the same time makes a fellow realize that there is more to a dx QSO than just "5R9".

ON4CSL's full QRA: Rev. Carroll R. Stegall, American Presbyterian Congo Mission, Lubondai, via Tshimbulu, Kasai, Belgian Congo.

Keying Monitor

[Continued from Page 72]

Once properly set up the system works remarkably well; any changes in tone indicate that a change has taken place in the transmitter. This type of monitor has been found very satisfactory at W9EGF.

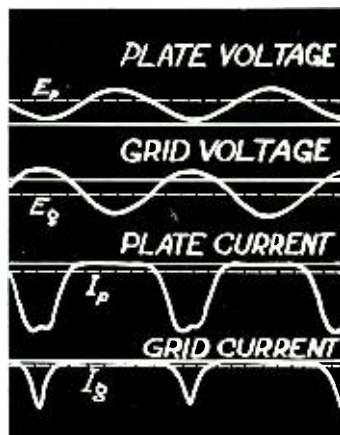

Are the Filaments of Your Present Tubes Capable of Supplying the Peak Demands of Emission

for class C operation? Your plate milliammeter measures only the average space current and does not show the peak values as does the oscillograph. Peak plate currents are often ten times the average. An abundance of filament emission means low tube losses and larger outputs at high efficiency.

The Type 354 Gammatron uses 50 watts of filament power to supply a total emission of over 3 amperes. This Gammatron has a maximum plate current rating of 300 milliamperes.

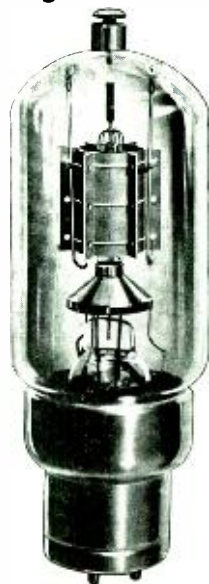

Class "C" Operating Data for TYPE 354 GAMMATRON

Plate Voltage	Plate Current	Input Watts	Output Watts	Plate Eff., %	Excitation Volts-Eff.	Grid Bias	Grid Current	Driving Power
1500	.285	430	320	74	459	— 428	.050	30 Watts
2000	.285	572	450	78	575	— 602	.045	35 Watts
2500	.285	715	580	81	735	— 814	.040	40 Watts
3000	.283	850	700	82	855	— 960	.037	45 Watts
3500	.285	1000	850	85	1030	—1180	.036	53 Watts

WRITE FOR BULLETIN 354-D

TYPE 354 GAMMATRON

\$24.50 NET

USED BY LEADING AMATEURS
STOCKED BY LEADING DEALERS



SOUTH SAN FRANCISCO

CALIFORNIA U. S. A.

F.O.B. SOUTH SAN FRANCISCO



Diversity Reception

By DON CANADY

Diversity reception immediately brings to mind spaced antennas requiring more land than is available to the average amateur. Tests conducted over a period of three years prove conclusively that diversity reception can be accomplished to good advantage without any more space than that required by the usual doublet.

Instead of using two or more horizontal antennas spaced a few wavelengths apart, use is made of a vertical doublet suspended under the horizontal doublet.

Experience has shown that when the signal fades on the horizontal antenna, it increases in strength on the vertical antenna. During periods of severe fading of the rapid "swishing" variety, and with the two antennas feeding into two receivers working diversity fashion, good program material can be obtained from a signal that would otherwise be worthless when received on one antenna.

For those who do not have an extra receiver available, transmission lines from the two an-

tennas can be brought into the station and terminated at a double pole-double throw switch at the receiver. This will enable the use of either antenna, depending upon conditions.

When receiving conditions are good and fading at a minimum, the horizontal antenna will usually deliver the strongest signal. The vertical antenna is more susceptible to man-made interference but during unsettled conditions the horizontal antenna has, at times, had the highest noise level.

Signals from the Byrd transmitter while at the South Pole were always several db higher on the vertical doublet. On several occasions when the vertical antenna was delivering a fairly strong signal, nothing but noise could be heard on the horizontal one. This was night reception (Cleveland).

Work on diversity reception has been done between 18 and 40 meters only, European short wave broadcasting stations being used as "key" stations for daily check and test.

From the many antennas tested at this location, results show that directional antennas "whittled down" to fit the usual back yard are worthless due to the proximity of power lines, etc. In restricted areas the half wave doublet has the highest signal/noise ratio. Antennas one, and one and one half wavelengths long are noisier than the half wave type.

An ideal arrangement would be to have the doublet arranged so that it could be lengthened or shortened at will. Operating the doublet at exactly $\frac{1}{2}$ wavelength is more effective than tuning a coil-condenser arrangement at the receiver.

Twisted pair transmission cable is used to connect doublets to receivers. Different types of cable have been used with varying success. Considerable trouble has been experienced with cable rapidly deteriorating due to wind and weather. This difficulty appears to have been solved by the use of the new special 72 ohm cable. After being exposed to severe wind and sleet this cable shows no signs of breaking down and still has very high insulation resistance.

DIATHERMY



All parts for construction of the Diathermy machine which is described in this issue are now in stock.

Especially is your attention called to the fact that we always have on hand the exact pads which are used in the laboratory model.



Radio Television Supply Co.

1701 SO. GRAND

LOS ANGELES, CALIF.

LOW-LOSS
MICA
CONDENSERS

800%
Better Than
Bakelite



FOR DETAILS
WRITE
Pat. Pend.

Dumont Electric
Co., Inc
514-516 Broadway
New York



Transmission Observations

Mr. Fred Reid, Jr. requests that we ask readers to look through their logs for evidence on some transmission effects observed at Seattle by a group of amateurs including R. D. Hoffman of W7DL, O. M. Johnson of W7FD, C. R. Stevens of W7PX, and Reid himself at W7EJD.

Lunar Effects

Observing on station HPC at Panama City on 6985 kc. and TDC in Manchukuo on 13,985 kc., both at about 5000 miles, it was found that during October and November of 1934 and October of 1935 the signals were stronger in the dark of the moon. During a time of full moon the signals did not appear until the moon had sunk to within 45 degrees of the western horizon. This ran in 28 day cycles, necessarily overlaid by effects due to weather. During the heavy rains of October, 1934, 7 mc. signals were very good. During October, 1935, both bands worked well, to the west, during the morning from 6 to 8 a.m., while 14 mc. naturally was better after sunrise.

In the spring of the year, during a dx contest, a full moon appeared and conditions were

not at their best. On the other hand, during April, May, and June European signals from Europe came in very strongly on 14 mc. during the full moon. The first week in April the conditions were very good; both 7 and 14 mc. signals came in from all over the world at all hours when stations were on the air.

It is to be noticed that some of the foregoing statements contradict each other.

Incidentally, Mr. Reid made a 10,000 mile contact during the July 1935 total eclipse of the sun with R9 signals at both ends.

"It will be of interest to have others who find time make similar observations and to compile the data for future use. These effects vary from year to year, but once the effects are understood all the amateur has to do is to pick the right time of the month—and good dx is his."

It will be interesting to have the observations of the northwest group checked. Their observations are not from one station or equipment alone. The receivers used included a Parterson PR-10, National FB7, a National SW3. Various antennas were used at heights of 30 to 90 feet and with lengths of 200 to 600 feet.

CARDWELL . . . recommends **for your 500 WATT CLASS "C" FINAL RF AMPLIFIER** **using 50-T's, HF-200's, 852's, 838's, RK-28's and Similar** **Tubes. Efficiency Modulated.**

FOR SINGLE ENDERS



XC-100-XS
\$6.90 net to hams

SPECIFICATIONS

- 6000 Volt Peak
- .200" Air-Gap
- MYCALEX Insulation
- Buffed & Polished Plate Edges



FOR PUSH-PULL

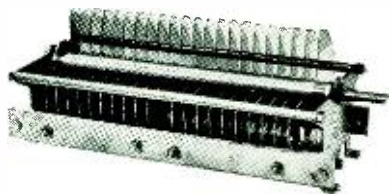

XC-75-XD
\$10.20 net to hams

CARDWELL CONDENSERS ARE SPECIFIED THE WORLD OVER BY ENGINEERS, EXPERIMENTERS AND AMATEURS!

There's a CARDWELL for every purpose—your dealer carries a complete line. The CARDWELL 1936 Catalogue, describing every condenser in the CARDWELL series is available — Write for it.

THE ALLEN D. CARDWELL MANUFACTURING CORP'N.
81 PROSPECT STREET • BROOKLYN, NEW YORK



**"ALL
EXPENSE"
TOURS
ALSO
AVAILABLE**

◆ **CRUISE** around the world on a tour of your own planning—a cruise personally conducted by no one but yourself. Go where you please, stay in any land that suits your fancy. And your ticket is good for two years. Roam the seven seas—on either

side of the equator. New thrills await you... the mysteries of Asia... enchanting Bali... the spell of India... the drums of Africa... the Holy Land... Europe, New Zealand, Australia. Where do you want to go? Come in and discuss your plans with us. Over 200 itineraries from which to choose. Special round the world service.

Send for Descriptive Booklet

Information regarding the various routes, fares and sailings are included in our new booklet, "Independent Round the World Tours". Ask your local agent or the Canadian Pacific: New York, Chicago, Los Angeles, San Francisco, Montreal and 32 other cities in the U.S. and Canada.



GIVE AMERICA CREDIT

The ultraudion circuit is as American as a soda fountain. It is an oscillator first worked in this country, and diagrams of it appear in some tolerably old American records.

If Europe wishes to call it by some other name as "Gutton-Touly", that will be all right with us, but we object when our American writers begin to follow the fashion and present our good native ultraudion as a European 5 meter circuit.

It took no ingenuity to make the ultraudion work at 5 meters. On the contrary, once it is tuned to 5 meters it does not stop oscillating even if the plate voltage is cut off; one has to dim the filament to stop the thing. If it is ingenious to make such a circuit start oscillating then it is also ingenious to fall down stairs.

Besides, why credit Europe with any part of the matter? The dates commonly given for the European invention seem to be quite a bit after the ultraudion had been used with various tubes at 5 meters in this country without any thought of invention. It was done by merely trying all the well-known oscillators at 5 meters and finding that the ultraudion stood out at 5 meters. The ultraudion was well known then in America.

**As much Current
as you want...**



**with
WARD
LEONARD
Ring Type
RHEOSTATS**

These power rheostats provide a fine continuous adjustment. No steps to consider. The contact arm travels smoothly around the windings providing as much or as little resistance as desired. These and other Ward Leonard rheostats, resistors and relays for the amateur are shown in the new Bulletins 507 and 507B. *Send for them today.*

WARD LEONARD ELECTRIC CO.
41 South Street, Mount Vernon, N. Y.
Please send me bulletins 507 and 507B.

Name.....
Address.....
City.....State.....
Call Signal.....RR9

Free Handbooks!

Each month we will pick at random from the latest callbook several amateur calls and list them somewhere on the "Marketplace" page among the classified ads. If the holders of the calls listed will drop a postcard to RADIO to the effect that they have noticed their call, they will be mailed free a copy of the 1936 "Radio Handbook". This card must be postmarked before the 15th of the month on the cover of the issue in which the call appears.

Police Radio Operators' Manual

POLICE RADIO OPERATORS' MANUAL. Published and distributed by the Radio Department, General Electric Company, Schenectady, New York. Price \$1.00.

This book, written by several General Electric radio engineers, is primarily intended to assist policemen who desire to become radio operators. However, it is equally useful to those who desire to become operators of broadcast stations.

The first section is devoted to general information on police radio systems; the second to typical questions and answers of examinations for first-class radiotelephone operators, and the third to supplementary information.

The majority of the book is taken up by the second section which includes questions and answers in sub-sections titled "Radiotelephone Transmitters", "Receivers", "General Principles of Electricity", "Operation and Care of Storage Batteries", "Power Supply Apparatus" and "Radio Communication Laws and Regulations". Several essential diagrams are shown including the complete circuit diagram of a modern broadcast transmitter.

Astatic

D-104 CRYSTAL MICROPHONE THE AMATEURS' FAVORITE

The D-104 Astatic Grafoil Crystal Microphone is the choice of veteran amateurs because of its uniform quality performance—its constant dependability and ruggedness of construction.

Licensed
under
Brush
Development
Company
Patents
•
Fully
Guaranteed



Get
Details
from
Your
Jobber
•
List Price
only
\$22.50

ASTATIC
Crystal Microphones and Pickups
ASTATIC MICROPHONE LABORATORY, Inc. YOUNGSTOWN, O.
Pioneer Manufacturers of Quality Crystal Products

NEW 1936 ATR DC - AC INVERTERS For Producing A. C. CURRENT ANYWHERE In CARS • on FARMS • in D.C. DISTRICTS

Featuring

- **Interference Free All-Wave Radio Operation**
- **New Improved Long Life Vibrators**
- **Four Point Voltage Regulators**

PROVEN -- DEPENDABLE GUARANTEED

... for operating STANDARD A.C. RADIOS, PUBLIC ADDRESS SYSTEMS, TESTING EQUIPMENT, fans, vacuum cleaners, mixers, hair dryers, curling irons, medical appliances, and all other similar A.C. equipment.

TYPE	D.C. INPUT	A.C. OUTPUT	MAXIMUM CAP.	LIST PRICE
6	6 volts	110 V. 50-60 Cycles	50 watts	\$18.50
12	12 volts	110 V. 50-60 cycles	100 watts	\$18.50
32	32 volts	110 V. 50-60 cycles	100 watts	\$18.50
110	110 volts	110 V. 50-60 cycles	200 watts	\$18.50

Inverters for various D.C. input voltages from 6 to 220 volts D.C. and A.C. outputs of both 110 and 220 volts are also available

Write or Wire for Additional Information.

Sold by Leading Jobbers Everywhere.

AMERICAN TELEVISION & RADIO CO.

St. Paul, Minnesota, U. S. A.

Cable Address: "LIKEX" New York



List Price

\$18.50*

*Without radio filter. \$22.50 with built-in filter.

Specify Type Desired
STANDARD DISCOUNTS APPLY



SIGNAL PATHS

By GUY FOREST

Nearly every short-wave listener, dx fan, or amateur has a map of some sort—ordinarily a Mercator projection of North America or of the world. However, due to the fact that this world is a globe, none of the common maps on a flat surface gives a true idea of distances and directions. This is especially true in short-wave transmission and reception, where the entire surface of the world is involved.

It is an established fact that radio signals arrive at a receiving location along the great circle path: in other words, by the shortest and most direct route. A good way of visualizing a great circle is to imagine that the Equator could be picked up and slipped over the face of the world, until it ran through both the transmitting and receiving locations. There will be only one position of the Equator that will satisfy the requirement, and that position corresponds to the great circle going through the sites.

Transmission occurs normally over the shortest portion of the circle; and numerous measurements by various organizations show that the waves arrive at the receiver within one or two degrees of the great circle direction. This is pretty good proof that whatever is heard at a given spot in the world leaves the transmitting antenna also within one or two degrees of the great circle route to that spot.

Occasionally, the signals go the long way around and come into the receiver from behind, but they still arrive over the great circle path. Except for entirely negligible freak effects, transmission and reception occur over definite paths, and there is no such thing as, for instance, "following the line of darkness."

There is a kind of map published which is made to order for determining signal paths. The whole surface of the world is drawn spread out on a flat sheet, using one spot for the center. Since all lines over the globe starting from the center must meet at a point exactly on the opposite side of the world, the outer circumference of the map corresponds to this point: the antipodes. If there were a little one-mile island exactly at the antipodes it would, on this map, stretch entirely around the rim. Similarly, land areas near the edge are distorted from the common Mercator showing. This is one reason why the antipodes is comparatively easy to hear, or to work, because any direction from the transmitter is a great circle route and the signals have a much greater chance of finding a path through favorable conditions of light, season, layer height, and so on.

A glance, then, at such a map will indicate the approximate direction to any spot on earth; and a straight line or string from the center to any point in question will run the true direction and shortest distance to that point. The length of the string, scaled off with a ruler, is the correct distance; the reading in degrees on the outer edge of the map is the true great circle bearing.

This map makes apparent facts which prove

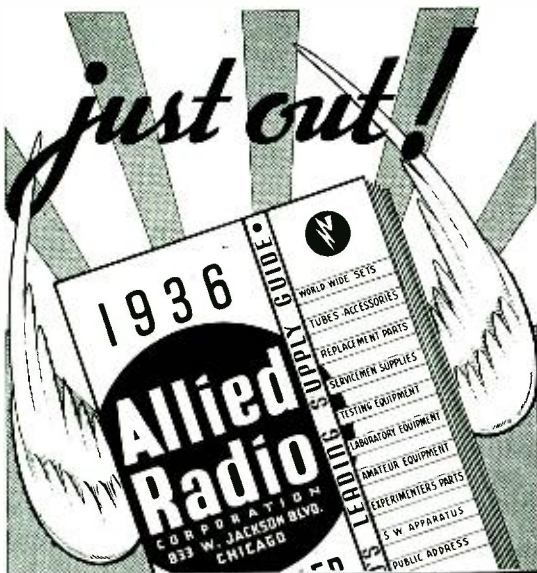

Allied Radio Corporation
833 W. JACKSON BLVD., Chicago

Send me your FREE 1936 Spring and Summer Catalog. Dept. J.

Name _____
Address _____

FREE MAIL THIS COUPON

HAMS—SERVICE MEN—EXPERIMENTERS . . . DON'T BUY RADIO SUPPLIES until you get OUR 65-PAGE CATALOG!
R.C.A. variable output transformers from any \$1.25 tube to any size voice coil ½ ohm to 500 ohm line.
G.E. 2000 working volt 2 mfd. filter condensers 95c Each.....

AIREX CO.
Radio Bldg. Plane and Market St. Newark, N. J. Dept. R.



the fallacy of conceptions gained from geography or atlas maps. For instance, if you live in New York City and pick up station VUB in Bombay, India, you are getting the signals from right over Hartford, Conn., almost northeast. To hook up with a lot of South African stations, an amateur in San Francisco must place his transmitting antenna so that it shoots a maximum of radiation about 10° north of east! Most everyone would guess that it should point southeast.

Using such a map is easier than scaling off a globe of the world, and of course is much more economical to possess. Your own Uncle Sam will sell you one for 40c, through the Hydrographic Office, U.S. Navy Department. Two maps are published. One is Chart No. 5199 drawn with Washington, D. C., as the center, and the other is Chart No. 5199a drawn with San Francisco as the center. Each is 24 by 26 inches, which is large enough for easy reading. Either map will give tolerably accurate results even if used at places a few hundred miles from the city used as a center. Chart No. 5199a has curves of radio skip distances and ranges on the back.

Such a great-circle map (of reduced size), centered on San Francisco, was shown on page 39 of the February, 1936 RADIO. In the near future maps centered on Kansas City and Washington, D. C. will be run. These smaller azimuthal charts will suffice for most purposes, the larger ones furnished by the Government being useful when greater accuracy is necessary.

SUPER-SIGNAL

The Supreme Oscillator. Drift less than 2 ppm 160-80-40.
\$5. ± 5 kc. \$5.50 ± 1 kc.
V-cut 160-80, \$2.50. AT-cut 160-80, \$2.25.
25c added for ± 1 kc.

ROY L. GALE, WIBD, 41 Beacon St., Barre, Vermont

A NEW 10-20 METER TUBE

ZT4B

FULL OUTPUT 200 WATTS. PLATE VOLTAGE 1000—Single 210 Will Excite to Full Output.

50 WATT BASE GRID-PLATE CAPS

POSTCARD BRINGS MANUAL

PRICE \$17.50

NATIONAL RADIO TUBE COMPANY
3420 18th Street San Francisco, Calif.

Let's Get Together

It is to your advantage to buy from me. Your inquiry about any amateur apparatus will prove that to you.

I give you specialized personal service of genuine value that is not available from other jobbers.

I take in trade used apparatus. I sell on time payments.

I stock at wholesale prices all amateur apparatus. I am jobber for Collins, RCA, RME, Marine transmitters. Trade in your transmitter. Buy on time. Write for information.

I have in stock the new All Star transmitter kits. Supplied assembled at nominal cost. Also Radio-Silver transmitters.

I ship all receivers on ten-day trial. You need send but \$5.00 with order.

TRADE IN YOUR TRANSMITTER OR RECEIVER

The new ACR-175s complete.....	\$119.50
PR-16C's complete prepaid.....	101.70
PR-16's complete prepaid.....	95.70
National HRO Jrs.....	99.00
Super Pros complete (At Last).....	194.04
RME-69s.....	118.80
National HROs.....	167.70
Bretting 12s complete prepaid.....	93.00
Super Skyriders complete.....	79.50
Silver 5Ds complete prepaid.....	109.80
RCA ACR-136s complete.....	69.50

Every inquiry and order is personally attended to by Robert Henry, W9ARA; an active amateur for eleven years; graduate E.E. from M.I.T.; and owner of Henry Radio Shop selling amateur apparatus for seven years. You can reach me by letter, telegram, or phone call 24 hours a day, 365 days a year. When in a hurry order from W9ARA. Write for any information.

HENRY RADIO SHOP

211-215 North Main Street

Butler, Missouri

New — Improved OHMITE R. F. CHOKES

4 Sizes

For use on 5
to 160 meter
transmitters



• These OHMITE R. F. Chokes have many new features. They are single-layer wound on ceramic tubes, and coated with a moisture-resisting material which anchors the turns firmly in place. Ample space is allowed at the ends of the choke to prevent flash-over to ground when mounted by means of the mounting brackets furnished with the unit. They are described and their use fully discussed in a whole chapter of the new OHMITE Amateur Handbook. Get a copy from your dealer, or send 10c to:

OHMITE MANUFACTURING CO.

4837 Flournoy Street

Chicago, Illinois



10 Meter Phone—C.W.

[Continued from Page 59]

60 or 70 volts bias is obtained from the cathode resistor R_6 , which is by-passed for audio and radio frequencies.

Unity coupling does not give as much grid drive as link coupling but it has the advantage of conserving space, because two tuned circuits are thus eliminated. The baseboard is of such size that it will fit into a standard relay rack, and the controls, except one, are placed symmetrically. That one can be driven with a flexible shaft to have symmetrical front panel controls if desired. The plug-in coils use small-sized Johnson coil plugs and stand-off insulators for quick change from 10 to 20 meters. This set can be built for a total cost of about \$65.00. Using the parts on hand in most amateur stations, the cost of getting started on 10 meters should be even less.

A K6 has applied to the courts to change his name to Radio.

Chicago is America's noisiest city, according to recent measurements by sound engineers.

HOYT SETS THE PACE



Modern design D.C. Milliammeters, Ammeters and Voltmeters in smart bakelite cases now ready. The new R.F. Antenna meters have INSULATED ZERO ADJUSTER! Scale length of these instruments is 3/4 inches! Dress up your panels with these good looking, ruggedly built meters. Instruments are 1/2 inches square, and mount through a 2 13/16 inch hole. All meters reasonably priced. Ask your jobber for these smart new instruments or use coupon below.

THE BURTON-ROGERS CO.

755 BOYSTON ST. BOSTON, MASS.
SALES DIV. OF HOYT ELEC. INST. WKS.
Gentlemen: Send me catalog RM-3, giving full information about the Hoyt Modern Meters.

Name.....St.....

City.....State.....

Crystal Calibrator

[Continued from Page 67]

directly available. Of these 17 points it is possible to hit three with both the "Hi" and "Lo" range, six with the "Lo" range, five with the "Hi" range. This leaves but three which cannot be spotted directly and all of them have values such that they are easily interpolated on either receiver or oscillator (monitor, that is) with considerable ease and acceptable accuracy. The guaranteed accuracy of the crystal calibrator is 2 parts in a million, and any large accidental drift can readily be checked by going to the nearest broadcast receiver, tuning in any station operating on 600, 700, 800, 900, 1000, 1100, 1200, 1300, 1400 or 1500 kc. Several such stations are available every evening and if one is off the others will give the fact away. The crystal oscillator has a trimmer for adjusting to zero-beat the station which is being received. For this work d.c. (battery) plate supply is used on the oscillator.

Transmitter Adjustment

As an amateur transmitter should be operated with some manner of calibrated "monitor" it is always possible to spot points on the monitor scale 100 kc. apart, permitting use of the monitor as a frequency meter. This allows one to compensate the meter each time before a reading, instead of bothering to build an expensive meter with long-time accuracy. At some operating frequencies it is of course possible to hear a beatnote in the non-oscillating monitor when the calibrator is placed rather near the monitor and across the room from the transmitter. It is not necessary to work at exactly zero beat in most cases.

All of the foregoing things have been tried here and were done more readily with the TMV-133A than with any other device previously used, largely because of the two-frequency feature.

Maldon, England and its American name-sake, Malden, Massachusetts, were in touch recently when W1CTW worked G2MR.

7000 Kc XTALS

Thick C&S cut—Highly Active—
Low Drift—Single Freq.—Cleaner
Note—Close to Freq. Guaranteed **\$2.25** p.p.
80M-160M—C & S cut as above.....\$2.00 pp.
80-160M—Thinner Cut Low Drift.....\$1.35 pp.

C&S XTALS

836 E. WEBER AVE. STOCKTON, CALIF.

LEEDS... leads again

OF COURSE the "NOISE SILENCER" is the greatest aid to radio reception in years.

OF COURSE our engineering staff was immediately alive to the vast field of application of a small adapter to thousands of superhets, both amateur and B.C.L. **Soooo** we developed the LEEDS "QUIET CAN", an amazingly compact dingus housing all the necessary parts and tubes. Just bolt the Quiet Can on the cabinet making three connections, observe a few precautions as outlined in the instructions, and say Goodbye to noise.

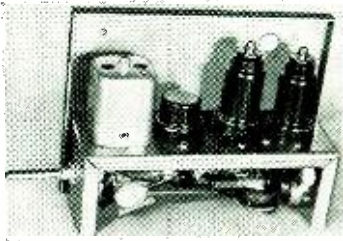

On the left we have an inside view of the Quiet Can measuring only 2 1/2 x 5 1/4 x 6 1/2 overall with cover. Filament supply is ingeniously obtained by the use of a resistance type line cord with the tube heaters in series, eliminating the bulk and hum producing possibilities of a filament transformer.

On the right we picture the Quiet Can mounted on an FBXA with noise control conveniently located near the crystal controls. A hole in the chassis is provided, so that the potentiometer may be turned at right angles, the shaft extended and brought out of the front panel.



You bet we figured on thin pocketbooks and quantity sales. By buying large stocks of material we are able to pass on a considerable saving to you

The complete unit with 3 tested R.C.A. metal tubes and installation instructions..... **\$5.85** The Quiet Can wired and tested with R.C.A. tubes. IF aligned to your IF frequency..... **\$8.55**
Shipping weight 5 lbs. Like all Leeds products the "Quiet Can" is unconditionally guaranteed.

GENERAL RADIO VARIACS



Are the ideal answer to the QRP problem. Type 200 CU delivers 0-135 volts continuously variable at 900 watts from 115-volt line. Price **\$14.50**

Type 200-B - 0-115 volts at 170 watts. Price **\$10.00**

No. 100-K 0-115 v at 2000 w. Price **\$40.00**

LEEDS Leads as the only distributor in the country, handling G.R. Amateur accessories and laboratory apparatus. Bulletin No. 936 mailed on request.

GENERAL RADIO coil forms type 677-U price 50c; type 677-Y price 75c. G. R. amateur accessories always in stock.

G. R. dials, with fluted knobs 4" - **\$1.50**; 3 1/4" - **\$1.25**; 2 3/4" - **\$1.00**.

A THIN DIME

Now that the 1936 bulletins are available, we are renewing our offer of last year. A thin dime brings to you post paid the latest bulletins of 25 manufacturers of short wave equipment, together with our own B-73 bulletin. Far more information on the latest and best short wave equipment is contained in this assortment than can be found in any mail order catalog. Write for yours today.

PREMIER Midget Magnetic Speakers

SPECIALLY PRICED

3 inch **90c**; 5 inch **\$1.00**; 6 inch **\$1.20**

WESTINGHOUSE and SANGAMO watt hour meters, illustrated last month: 110-120 volt, 60 cycle, 2-wire meters; 5-10-25 and 50 ampere capacity **\$3.50**
Shipping weight 15 lbs.

LEEDS offers outstanding values in quality transmitting Tubes, backed by our name and guarantee.

*203-A.....	\$8.45	†830-B.....	\$7.25
†210-HF.....	1.75	*838.....	11.75
866.....	1.50	†841.....	2.95
301-A-UHF.....	9.45	*852.....	11.50
†801.....	2.95	866-A.....	1.95

*Graphite Anode Tubes
†Isolantite Base

Tubes Shipped by Express Only

MEISSNER FERROCART iron core transformers. These units will increase selectivity, double the gain, increase signal, lower set noise.

175-262 370-456 kc. each. **\$1.18**
MEISSNER IF transformers: micatuned, all ranges as above. **73c** Each.

BE NONCHALANT

If the "R" walks in. Have a LEEDS 1-B Freq-Monitor on the operating table. A Freq-meter to comply with the "regs." and an FB Monitor **\$19.75** too. Price, complete.....
Power supply..... **\$6.50**

THORDARSON TRANSFORMER special, 1200 volts CT 200 ma. 5 v. 3 amp. 7 1/2 v. 3 amp. 2 1/2 v. 10 amp. a quality case job..... **\$2.45**

Thordarson 12 hen. 250 ma choke **1.95**
Thordarson cased class B transformers input and output.
For 46's. Per pair..... **\$6.17**
For 210. Per pair..... **8.23**
For 203-A. Per pair..... **17.64**

Aladdin Iron Core in stock I-F Transformers \$1.75

No. 100 - 465 Kc. Pri. 1.5 mh. Sec. 1.5 mh.
101 - 465 Kc. Pri. 1 mh. Sec. 1.5 mh.
200 - 165 Kc. Diode; pri. 1.5 mh. Sec. 1.5 mh.
201 - 465 Kc. Diode; pri. 1.5 mh. Sec. 1 mh.

Wet Process 1" Diameter Glazed Porcelain Insulators

Wet Process 1" Diameter Glazed Porcelain Insulators
7".....25c 12".....35c 20".....50c
Egg-type strain insul. 10 for.....35c



LEADS THE FIELD
World Wide Service to Amateurs

43 Vesey Street
New York City

Telephone Cortlandt 7-2612
Cable Address: "RADLEEDS"

New CROWE Items NOW AVAILABLE

"Change-O-Name" Dial Plates

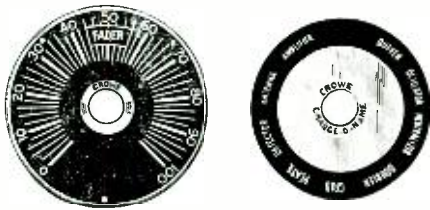

The handiest thing ever devised for the Amateur. Consists of a selective name disc placed back of a dial plate with an opening in which the desired name appears. The name disc contains a series of names, such as: Amplifier, Antenna, Buffer, Detector, etc. By simply turning the name disc to the required reading, you have a Name Dial Plate, and it can be instantly changed to read something else should a change be made in the circuit. Dial plate is of Anodized Aluminum with silver-white figures on a brilliant black background. Name disc is of Anodized Aluminum with white letters on a red background. Made in two sizes: 2 3/4" and 1 7/8" dia. Calibrated 0-100 in 180° and 270°. You should have a supply on hand at all times.

New Micromaster Dial

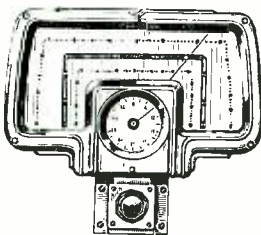

No. 481 Rectangular Micromaster Dial. Combines beautiful appearance with extremely fine band-spread tuning. Two-speed planetary drive, slow ratio about 100 to 1, fast ratio about 18 to 1 in 360°. Scale approx. 3" by 6". Calibrated 0 to 100.

Precision Instrument Controls



No. 525 "Front-O-Panel" Airplane Dial with two-speed planetary drive. Slow ratio about 165 to 1, fast ratio about 30 to 1 in 360°. Very smooth and extremely accurate. Perfect for Short Wave tuning. Also made as a single speed unit (No. 526) with ratio about 30 to 1.

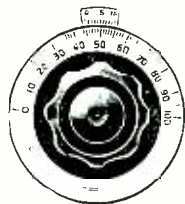

No. 296 "Plan-O-Vernier" Genuine Reduced Speed Dial with stationary Micrometer marker. Ratio about 5 to 1 in 360°. Smooth planetary drive concealed in knob. Dial is 4" in dia. Calibrated 0 to 100 in 180°. Also made with 270° calibration as No. 297.

Carried in stock by Leading Jobbers and Dealers Everywhere.

Write for Bulletin No. 75 showing many new items. Representatives in Principle Over Seas Markets.

CROWE NAME PLATE & Mfg. Co.
1755 GRACE STREET CHICAGO, ILL.
Cable Address: CRONAME-CHICAGO

DX News

(Continued from Page 62)

(and that's not all), and handles the Comet Pro like an old timer." Er, ah . . . that is . . . take it easy Johnny . . . I mean with your stamp collecting. G2ZQ is W38Z and has worked 111 countries.

Did you know that G6WY has worked 119 countries, G5YH and G6KP over 90.

W2GWE gets a good one in hooking YU7GL. He was T9 and 14,400 kc.

W8DVS still uses his '10, works VQ8AB, U9ML, and VS6AF on 14 mc.

W9KG has been all hot and bothered lately over the extra good conditions. On 14 mc. U2NE, ZE1JR, YL2BR, FB8AB, VQ8AF, LA1M and a few D4's have been coming through from 9 p.m. to 1 a.m., c.s.t.

W9ARI is now on with 1 kw. into p.p. 852's working a bunch of Africans and other good dx. W9LBB is still plugging along with his 10's and getting his share, which include FB8AB and FB8AG. W9DPJ is doing his stuff on 20 with parallel 276A's in final. W9GDH is coming to life . . . probably for the contest.

W8CRA breaks down and gives a few stations that are being worked quite regularly with his peep-squik. Among them are J3CR, ES1C, VS6BD, VS6AH, VS6AS, VS6AX, VS6AQ, VS6AK, CR7GD, CR7AL, CR7AD, VU2JB, VU2JP, VU2BG, VU2EB, VU2AY, VU7FY, VU2LZ, VU2CQ, VU2EQ, VU2LJ, U40L, U5AE, U9MI, U9AV, FB8AG, KA1ME, FR8VX, PK3BX, PK2BO, PK1JR, PK1CX, PK1GW, KA1AP, KA1AN, KA1LB, XU3ST, VQ3FAR (ex-G5FA), XU8AL, OX7ZL in Greenland (about 14360 kc.), VQ8AB, VQ8AF, VQ8AC, ON4CRM, J2ML, J2JK, J2CL, J8CD, J8CA, ZD8A and about 40 South Africans and 6 ZE's. ON4CRM is a new one on 14,380 kc. Frank gleans a piece of news from



VS6AF. It seems that VS6AG was married recently and to further his good fortune won 9000 bucks on a horse race. Says he will soon be on with a real potent sig. This guy Lucas still is able to find new countries . . . his no. 115 was FOSAA, Tahiti, and no. 116 just the other day was PZ1AA.

VQ6A . . . does anyone know him . . . or rather his QRA? Also VP8A . . . who knows about him?

W4BBR and W4BBP in Atlanta are doing nice work. Both are using fairly low power . . . BBP uses a 203A and BBR has an 800 in his final. BBP is W35Z and BBR W32Z. W4CFD is doing nobly, also, working three U's around midnight. BBR, Pete Jones, and BBP, Ben Painter, have worked a number of Asians on 14 mc. and VK's as late as 8 p.m. c.s.t.

W8AAT, Ralph Ohle, was w.a.c. in 3 hours and 45 minutes, which is some accomplishment. All were worked on 14 mc., and the stations: VK3UJ, XU1B, OH3NP, FA8SR, LU8DJ, and XE1AM. No doubt this was a real thrill for him . . . that's not done every day. Ralph heard PK6AJ on 14,100 kc. March 4th about 10.30 a.m. e.s.t. working FB8AB.

W6BXU has never been on any other band but 7 mc., and is certainly doing himself proud. A few weeks ago he had a 100% QSO with LA2X, who came in around 7060 kc. LA2X is using a pair of German water cooled tubes with 1200 watts input in a t.p.t.g. rig. Hey, that's more than we can use here in W. BXU has heard SM7RV, SP1FI, EA8AL, and EA3EG . . . also wants to know why the deuce HR1UZ doesn't QSL.

Through the co-operation of Doc Leighner, W8OE, the results of the VK-ZL contest are listed; he copied them from a VK. Before grinding the list through the 'mill' I must get something off my chest. Last month in these columns an item contained the "flash news" that VK3EG was high point station in the VK contest, having 14,000 points. Right on the heels of the publishing of March RADIO I receive the complete results, and there was VK3EG with a great big 42,150 points! Was my face red??? Well, anyway it was a deep pink, and I decided to check up to see if I had forgotten the code, as I had copied the 14,000 from VK3EG direct a week previous. Needless to say I worked myself into a heavy lather and couldn't wait to hook up with 3EG again to find out who was ready for the 'bughouse'. He got a tremendous snort out of the whole thing, because it appeared that their Contest Committee had decided to give 5 points per contact instead of the 1 point as originally proposed. That accounted for the 42,150 points . . . to say nothing of giving me a good night's sleep.

1935 VK-ZL Contest

(VK-ZL Open)

VK3EG 42,150, VK3MR 23,750, VK3KX 21,812, VK7RC 21,384, VK4BB 20,240, ZL2CI 23,099, ZL1DV 19,680, ZL1GX 19,400.

(VK-ZL 28 mc.)

VK4BB 48,740, VK3EG 42,150, VK4AP 36,206, VK2LZ 36,180, VK3KX 25,312, ZL1GX 24,900.

(W-VE Open)

W1CMX 624, W2BYP 1566, W3EVT 1229, W4AJX 1550, W5EHM 3187, W6KRI 5040, W7DL 2190, W8ZY 2460, W9TB 4800, VE5BI 2070, VE3WA 216, VE1EP 144, VE4IG 108, VE2HG 72.

(W-VE 28 mc.)

W2DZA 1216, W3EVT 1729, W4AJY 1878, W4AJX 1550, W5QL 12,020, W5WG 10,941, W5EHM 2670, W5AFV 1294, W6GRX 7720, W6DIO 10,148, W7AVV 10,744, W9TB 13,350, W9IJ 6830.

J2HJ with 13,872 was the highest on 28 mc.

W6ITH (rig described in last month's issue) has only been on the air a short time with his phone rig on 14 mc., but has contacted 26 VK's and ZL's, HI5X, HI7G, LU5CZ, LU1EX, HJ1K and CE1BC. Tibbetts expects to be on 7 mc. c.w. very soon with his two 500T's on a frequency of 7000.001 kc. Owch!

Mystery of the Month: Why has W8CRA a raw piece of beefsteak over one eye? Black? Dunno. Somebody find out.

The other night was over to W6DOB's and he called ZE1JR for about an hour with no luck . . . this on 14 mc. He threw the cans on the desk and exclaimed, "Aw nuts, this is a h— of a band; me for 10 meters." After taking a slant at his log I couldn't blame him, as earlier the same day on 28 mc. he had worked 6-G's, ON4BJ, SP1DE, FA8BG, OA4J, HJ3AJH, K6CRU, VK3BD, VK3MR, VK3CP. His wife, W6AET, who is a real dxer, needs only Africa for her 10 meter w.a.c. . . . although the o.m. has QSOed FA8BG two or three times. Nice freeze-out, Lloyd. Guess I'll have to quadruple in the final and get in on this stuff.

Oh say, am I getting out . . . why, just the other day I received an s.w.l. heard card from the op on a battleship that's in San Pedro harbor. You see,

Now --- a high-powered ---

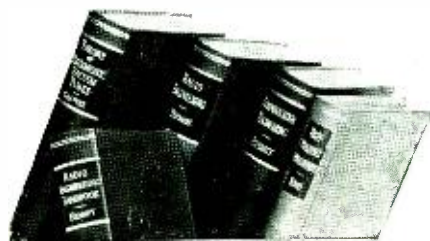

Radio Engineering Library

—especially selected by radio specialists of McGraw-Hill publications

—to give most complete, dependable coverage of facts needed by all whose fields are grounded on radio fundamentals

—available at a special price and terms.

These books cover circuit phenomena, tube theory, networks, measurements, and other subjects—give specialized treatment of all fields of practical design and application. They are books of recognized position in the literature—books you will refer to and be referred to often. If you are practical designer, researcher or engineer in any field based on radio, you want these books for the help they give in hundreds of problems throughout the whole field of radio engineering.

5 volumes, 2981 pages, 2000 illustrations

1. Everitt's COMMUNICATION ENGINEERING
2. Terman's RADIO ENGINEERING
3. Chaffee's THEORY OF THERMIONIC VACUUM TUBES
4. Hund's HIGH-FREQUENCY MEASUREMENTS
5. Henney's RADIO ENGINEERING HANDBOOK

10 days' examination. Special price. Monthly payments. \$26.00 worth of books cost you only \$23.50 under this offer. Add these standard works to your library now; pay small monthly installments, while you use the books.

SEND THIS ON-APPROVAL COUPON

McGraw-Hill Book Co., Inc.
330 W. 42nd St., New York, N. Y.

Send me Radio Engineering Library, 5 vols., for 10 days' examination on approval. In 10 days I will send \$2.50, plus few cents postage, and \$3.00 monthly till \$23.50 is paid, or return books postpaid. (We pay postage on orders accompanied by remittance of first installment.)

Name.....

Address.....

City and State.....

Position.....

Company..... R. 1-36

(Books sent on approval in U. S. and Canada only.)



The New 1936 Centralab Volume Control Guide

is off the press . . . more listings . . . way ahead . . . and up to the minute, including 1935 data never before shown. All listings "checked and doublechecked" and will be found extremely accurate. Keep abreast with this new Guide . . . and keep abreast with CENTRALAB Volume Controls and Fixed Resistors for ALL replacement jobs. Get a FREE copy from your jobber.

NEW! Up-to-the-minute

Centralab smoothness results from the action of the non-rubbing contact whereby a strip of polished metal rocks on the resistor . . . and the only rubbing action is between an oilless wood bearing and the polished metal.



Every Radio Service Man should be a member of the Institute of Radio Service Men

Centralab

Milwaukee, Wisconsin

RADIOHMS
SUPPRESSORS
FIXED RESISTORS
WAVE CHANGE SWITCHES

[Continued from Last Page]

'Pedro' is all of 23 miles from my 'shack' in El Segundo . . . and speaking of El Segundo, there's a town for you . . . it's about the size of . . . well, anyway if you're driving through it you can't go faster than 35 or you'll miss the burg. Getting back to the above 'dx' . . . it can only be attributed to the new 1200 foot antenna just recently put up. One afternoon my friend W8INY (who has been out here visiting for a month) and I decided to string an antenna to the top of an oil derrick about 1200 feet distant. We had to pick a windy day, of course, to climb that 125 foot derrick . . . but we did it, although the wind was sure doing its stuff up there. Took both of us to pull the thing up on the shack end, and even so it has a sag in the middle worse than in the ol' gray mare's back. The way it stands now it is about 1200 feet long, 120 feet high on one end and 40 feet at the other. Quite contrary to the above, it's not pointed for San Pedro, although it does nearly run into the next town. Yeah, that's right; all the better to work a flock of W9's.

Well, the Editor is yowling for his copy so that's a break for you fellows this time . . . but watch out for next month. Remember gang, this is your column, so send in that dx news before you forget it or it is stale.

HIGH FREQUENCY AUTO SETS

By JAYFNAY

We wonder why more manufacturers of automobile rad'os have not taken time to design and offer an all-wave automobile set. As far as we know, Remler, of San Francisco, is the only manufacturer who has tried it. The Remler receiver covers only two bands, and skips from 1500 kc. down to about 4 to 5 megacycles, then goes down to about 18 megacycles. The Remler job is essentially a broadcast receiver with taps on the coils and no high frequency preselection. In spite of this it performs surprisingly well. Now that the broadcast receiver manufacturers are beginning to realize that good high frequency performance is more than just tapping a few coils they are making some really good a.c. operated all-wave jobs. There is no reason in the world why those same chassis with a 6 volt pack and a good mechanical job throughout should not be available as auto sets.

It has been suggested that all high frequency auto sets should skip the police bands. We can see little point in that. Any criminal can build or get a service man or amateur to build him an auto set that will get the police signals if he wants them, which he probably doesn't now that the police are using coded signals.

In any case, a rather simple tapping arrangement on the 160 meter coils would allow the service department of each wholesale radio dis-



TRADE IN YOUR RECEIVER.

- HAMMARLUNDS-NATIONALS-RME 69
- M'MURDO-SILVER-PATTERSON, ETC.

SCHWARZ RADIO SERVICE

15 LAWRENCE AVE. DUMONT, N. J.

tributor to line each set up so as to skip the local police signals, if desired.

How about it, Mr. R.C.A. and Mr. Philco and Mr. Crosley? You all know that it is coming; so why not hurry it up a little?

Those Third Harmonics

Something had better be done about those third harmonics being radiated by some of the higher powered ham stations. Incidentally, many low powered stations also are offenders. The frequencies between 21,000 and 21,900 kc. (the third harmonic of the forty meter band) are just alive with signals at certain times of the day. All continents have been heard on the east coast many times and a short test on the west coast brought in dozens of dx signals. Probably one reason why these signals have not been noticed by the powers that be is that there are relatively few commercial signals in that band of frequencies and the government monitoring stations do not pay much attention to that territory. Incidentally, that would be a swell new band to get at Cairo, as it combines many of the characteristics of both 10 and 20 meters.

AMPERITE HIGH LEVEL VELOCITY

Operates WITHOUT PRE-AMP
HIGH IMPEDANCE—2000 OHMS
THIS MICROPHONE IS HIGH ENOUGH IN IMPEDANCE TO OPERATE DIRECTLY INTO GRID . . . BUT NOT HIGH ENOUGH (ONLY 2000 OHMS) TO INTRODUCE SERIOUS LOSSES IN LINE UP TO 200'.

Replaces condenser and crystal mikes. No changes necessary. Eliminates input transformer and its losses. Eliminates hum, trouble and feedback.

ELIMINATES HUM TROUBLE



MODEL RB-H. for speech and music. LIST \$42.00 with coupling. MODEL RS-H. for speech, but can also be used for music. LIST \$32.00 with coupling. Write for Bulletin H.

New! POSITIVE-AND-SMOOTH-ACTION STANDS



Positive, non-sliding, ball-bearing clutch! Will never wear out, never require adjustment. WILL NOT "CREEP". Tightens with only 1/8 turn of clutch. Mike can be tilted without loosening clutch. SMOOTH, PNEUMATIC-LIKE ACTION up and down. A model for every purpose. WRITE FOR ILLUSTRATED BULLETIN S.



AMPERITE Company 561 BROADWAY NEW YORK

AMPERITE HIGH LEVEL VELOCITY MICROPHONE

19" TABLE RACK



27 1/2" high, 10" deep. Drilled and tapped standard spacing 10-32 thread. Complete as pictured with 3—8 3/4 x 19" 14 gauge panels. 3—17 x 10 x 2" decks. Crackle finished. \$11.00 40 lbs. Rack only \$4.75 14 lbs. Send for circulars on other racks, panels, cabinets, etc.

R. H. LYNCH MANUFACTURING CO.
970 CAMULOS STREET LOS ANGELES, CALIF.

SETS on PAYMENT PLAN at New Lower Rates

The receivers listed below are the best money can buy. Our time payment plan, at the new low rates, makes it easy to own one. COMPARE our rates with others. THE EASY WAY: Send in your down payment with your order. Set will be shipped as soon as credit is OK'd. Entire Transaction: One week. TRY US. Write for complete catalogue.



New RCA-A R-175, See full Description on Back Cover

Cash Price	Down Payment	6 Months Payments	10 Months Payments
NATIONAL HRO JR.—with tubes—1 set of coils, 10 to 20 meters (2 amateur bands)			
\$99.00	\$24.00	\$13.52	\$8.20
NATIONAL HRO JR.—complete with tubes—power supply—2 pair of coils			
\$124.80	\$29.80	\$16.90	\$10.25
NATIONAL HRO—less power supply and speaker			
\$167.70	\$37.70	\$22.78	\$13.89
STANDARD HRO—with power supply			
\$183.60	\$43.60	\$24.46	\$14.93
NEW SUPER SKYRIDER—less crystal—Model S9			
\$79.50	\$19.50	\$11.00	\$6.67
NEW SUPER SKYRIDER—with crystal—Model SX9			
\$89.50	\$19.50	\$12.68	\$7.69
RCA—ACR—136			
\$69.50	\$19.50	\$9.32	\$5.65
RME69—complete with crystal—tubes—speaker housed in baffle			
\$134.90	\$29.90	\$18.58	\$11.28
HAMMARLUND SUPER PRO—Complete with tubes and speaker			
\$223.44	\$43.44	\$31.23	\$19.11
HAMMARLUND SUPER PRO—Complete with crystal, tubes and speaker			
\$241.00	\$51.00	\$32.92	\$20.16
PATTERSON PR-16—Complete with crystal, tubes and speaker			
\$101.70	\$26.70	\$13.52	\$8.20
NEW ACR-175—complete as advertised			
\$119.50	\$24.50	\$16.90	\$10.25

Full Details of Any Set Listed, Mailed Immediately Upon Request

WELL KNOWN OIL FILLED, OIL IMPREGNATED FILTER CONDENSERS

Our Special OIL IMPREGNATED-OIL FILLED CONDENSERS are guaranteed at rated voltages. All ratings are DC working voltage. These are well-known condensers purchased by us at a tremendous cut in price and passed on to you. We have a few left of each capacity. Send in your orders at once.

Cap.	Voltage	Size	Weight	Price
1 mfd.	2000 V. DC	5 x 3 1/4 x 1	1 1/4 Lbs.	\$1.25
2 mfd.	2000 V. DC	5 1/4 x 3 1/2 x 2 1/2	3 Lbs.	1.50
4 mfd.	2000 V. DC	2 1/2 x 2 1/4 x 5	3 Lbs.	2.25
8 mfd.	2000 V. DC	5 1/4 x 3 1/2 x 4	4 Lbs.	2.75
9 mfd.	3000 V. DC	5 1/4 x 3 1/2 x 11	9 Lbs.	7.25
(including 2 1/2" bakelite standoffs)				
4.4 mfd.	1500 V. DC	5 x 3 1/4 x 1 1/4	1 1/8 Lbs.	1.75
5 mfd.	1500 V. DC	3 1/4 x 3 1/4 x 1 7/8	1 1/8 Lbs.	1.90
5.2 mfd.	1500 V. DC	5 x 3 1/4 x 2 1/4	2 1/8 Lbs.	2.00
10 mfd.	1500 V. DC	5 x 3 1/4 x 3	2 3/4 Lbs.	2.75
20 mfd.	1500 V. DC	5 x 3 1/4 x 3 7/8	3 1/4 Lbs.	3.50

Use the 10 and 20 mfd. for perfect filtering in class B modulation Power supply.

Newark Paper Filter Condensers

1 mfd. 1000 V. DC...\$56
1 mfd. 1500 V. DC...66
These condensers have standoff insulators and mounting feet.

Thordarson No. T6877
Heavy Duty Choke. 15 henries at 250 MA. \$1.95

Thordarson No. T6878 Plate and Filament Transformers

600-0-600 V. at 200 MA. 2 1/2 V. at 10 amp. 5 V. at 3 amp. 7 1/2 V. at 3 amp. \$2.45

2 1/2 V. 10 amp. Filament Transformer—2500 V. insulation for 866's...\$95

All of the Above Specials are "NEW" and Guaranteed by Newark.

WRITE FOR OUR COMPLETE CATALOGUE!

NEWARK ELECTRIC CO.

FASTER SERVICE - BETTER BARGAINS
226 W. MADISON ST. DEPT. R CHICAGO, ILL.



How About a Crystal Handset?

The operators of portable and mobile phone stations are just about limited to single-button carbon mikes if they want the convenience of handset operation. Now that Brush has placed a pair of relatively cheap crystal phones on the market, why not a handset along the same lines?

The same type of diaphragm and crystal unit could be used in both the transmitter and receiver, provided some shielding is used around the transmitter portion. Many five meter rigs could easily be modified to provide an additional stage of audio ahead of the usual pentode modulator. One more stage would undoubtedly be enough as a handset is essentially a close talking device. While mobile operation is not legal on the lower frequency bands, portable operation certainly is, and many hams would be inclined to take a crack at 160 and 75 meter operation from a motor car if they could get reasonably good quality from a handset. Tests have shown that it is no trick at all to work over a fifty to one hundred mile radius with a 5 watt 160 meter phone working into a short rod antenna mounted on a car. 160 and 75 will do about anything that 5 meters will do and will chase around corners much better. Many hams who must practically give up amateur radio due to excessive noise at their homes QRA's would put a phone rig in a car and head for the nearest hilltop in order to get in some QSO's. Some really surprising dx has been worked from low powered rigs working into an 8 foot loaded rod on a car.



Improved

MIDGET CONDENSERS



Ideal as tuning condensers on high and ultra high frequency receivers, low power transmitters, and for neutralizing capacities of Xmitter tubes.

NOTE THESE IMPROVED FEATURES:

1. NEW POSITIVE WIPING CONTACT on rotor shaft with adjusting screw, eliminates mechanical noise on high frequencies.
2. CLOSE FITTING BEARINGS hold rotor to calibration and smoothness of operation.

Insulated with ISOLANTITE. Soldered brass plate assemblies, and heavy aluminum end plates make a precision built, ruggedly constructed condenser.

No. 900—Cap. 20 Mmfd.....	List \$1.15
No. 902—Cap. 35 Mmfd.....	List \$1.25
No. 903—Cap. 50 Mmfd.....	List \$1.35
No. 905—Cap. 100 Mmfd.....	List \$1.85
No. 906—Cap. 140 Mmfd.....	List \$2.00
No. 908—Cap. 200 Mmfd.....	List \$2.30
No. 909—Cap. 250 Mmfd.....	List \$2.45

Dual units and multiple spaced units in various capacities illustrated and described in our new catalog. Free upon request!

40% Discount to Amateurs

BUD RADIO INC.

1257 E. 55th STREET CLEVELAND, OHIO

SCRAMBLED SPEECH

- At last, the long waited hook-up of a speech inverter that will scramble or un-scramble speech.
- Build this new and interesting device. Opens a new field for experimenters and amateurs.
 - Turn your voice upside down—convert music into pandemonium—then un-scramble back into intelligible sounds.
 - Insures privacy of conversations over your own private telephone line or radio circuit. Amateurs can use the device on their phone transmitters.
 - Can be built from the usual junk-box parts—takes up small space—simple to operate as audio amplifier.
 - Other applications and features explained with diagrams. Circuit diagram with instructions 25 cent.—No stamps.

Wireless Specialty Co.

55 OAK LANE TRENTON, NEW JERSEY



TRANSFORMERS and CHOKES

Send for complete Reference Guide of Better Transformers and Chokes for all Receiver and Transmitter Purposes.

UTAH RADIO PRODUCTS CO.
Orleans St., Chicago

IT'S HERE Hallicrafters ULTRA SKYRIDER



5-10 METERS ★

*ACTUALLY 3.9 TO 46 METERS

THE ULTRA HIGH FREQUENCY JOB YOU'VE BEEN WAITING FOR ●

After months of work and experiment, the Hallicrafter engineers are finally satisfied. The Ultra Sky rider is complete—an entirely new approach to ultra high frequency reception. It's a super-sensitive Superheterodyne, with the new Lamb Noise Silencer to reduce the man-made noises so annoying at high frequencies. This new device, described in Q.S.T. will ensure practically noise-free reception.

The Ultra Sky rider fulfills the amateur's dream for 5-10 meter reception—it tunes up to 46 meters with the same high efficiency. In spite of its advantages, it's extremely moderate in price.

The Ultra Sky rider is the finest Hallicrafter product to date with more exclusive features than we can list here—you've got to see it and operate it for full appreciation of its marvelous efficiency.

See the new Ultra Sky rider at your jobbers on April 20, or write for full particulars now.

A M A Z I N G F E A T U R E ' S

- Fractional Micro-Volt Sensitivity 3.6 to 46 meters tuning on 4 bands. Lamb Noise Silencer, first time used on any commercial receiver, cuts out 60% of the noise prevalent on ultra high frequency bands.
- No Plug-in Coils
Individual Coils for each band
10 All-Metal Tubes
- Generous Isolantite and Steatite Insulator.
Continuous Electro-Mechanical Band Spread.
Iron Core Expanding I.F. Transformer.
- Built-in Power Pack
Frequency Calibrated Micro-Ver-nier 4-Band Dial.
Antenna Compensator
Moderate Price

the hallicrafters

THE HALICRAFTERS

3001-Y SOUTHPORT AVENUE, CHICAGO, ILL. • • CABLE ADDRESS LIKEX, NEW YORK CITY



AMERICA'S AMATEUR HEADQUARTERS

Mid-West Radio Mart

520 SOUTH STATE STREET
CHICAGO, ILL.

ANNOUNCE
THE APPOINTMENT OF

REX L. MUNGER, W9LIP

AS
GENERAL MANAGER

As usual—First with the Newest

LAMB "QST" NOISE SUPPRESSOR

Complete Kit of parts including drilled chassis. Raytheon tubes, 6.3 volt Filament Transformer and complete instructions.

Only \$7.95 Net

JONES - W9LIP 4 METAL TUBES SUPER-GAINER

Complete Kit of parts including drilled panel, one set of coils and complete instructions.

Only \$13.65 Net, less tubes

Write for descriptive circular describing these two "HOT" items.

Have you received the big MID-WEST Catalog?

RALPH O. GORDON

CONSULTING ENGINEER

High Frequency Radio
and
Sound Equipment

5708 Keniston Ave.
Los Angeles, Calif.
Phone University 7570

ERRATUM

6A6-42 Transceiver

In the drawing of the transceiver described by Frank Jones on page 25 of the March issue, a 0.5 meg. resistor should be connected from the bottom of L₂ (r.f. choke) direct to B plus. The error makes the set inoperative on "receive".

From Springfield, Ohio, we receive the suggestion that we issue two new certificates to the long list of those now existing, for the 5 meter amateurs: "W.A.B." (Worked all bootleggers) and "W.A.S." (Worked all streets). The nice thing about the latter is that it could be passed off on unsuspecting visitors as a "Worked all states" certificate.

"The Mayor", W6DDS, informs us that he has made W.A.C. on 160 meter phone (Worked all counties).

At the meeting of the American Medical Association in Kansas City, Mo., May 11th to May 16th, there will be held the first annual dinner for radio amateurs who are physicians. All amateurs intending to attend the A.M.A. convention should contact either W5ECL, W7DNP, W8CPC, or W9MXW for more details on this sidelight of the convention.

Both Edison and Carnegie started out in life as telegraph operators.

The Cornell-Dubilier Corporation announces their latest catalog for the transmitting and industrial fields. Catalog No. 127 contains twenty-four pages attractively illustrated, replete with technical information, covering a complete group of capacitors for the above fields.

The newly-designed Cornell-Dubilier line of Dykanol Transmitting capacitors is fully illustrated and listed. Copies furnished upon request at main office: 4377 Bronx Boulevard, New Ynrk.

ECONOMY CODE MACHINE for only \$12.00

LEARN CODE easily, quickly, at your convenience—

and economically. Famous Instructograph principle. Complete with choice of five tapes, and Book of Instructions. Delivered post paid anywhere in the U. S. A. Makes an ideal "CQ" or "TEST" Machine. Send Post Card for full details.



INSTRUCTOGRAPH CO.
914 LAKESIDE PLACE • CHICAGO, ILLINOIS

New 6G6 Power Pentode

The newest metal tube development looks particularly interesting to amateurs both for audio and radio frequency applications. The 6G6 is designed as an audio output pentode and has a 6.3 volt 0.9 ampere indirectly heated cathode. The suppressor grid is internally connected to the cathode.

The tube is still so new that final characteristics have not yet been released, but the following preliminary details are of interest.

One tube can deliver over 9 watts of good audio output with 300 volts plate voltage. This is as a class A single-ended pentode.

In push-pull running at 400 volts a maximum output of over 50 watts can be obtained by running the tubes as class AB pentodes. Over 30 watts of audio can be obtained without driving the grids positive, which means that an ordinary phase inverter or other low powered voltage amplifier can be used.

Bias requirements are around 25 volts, which means that an overall plate supply of 425 volts is all that is required. The screen voltage is held at 300 volts when the plate voltage is 400.

It is not yet known just how critical the tube is to changes in plate load impedance, but if it is not too critical it might be the ideal driver tube to drive a 500 watt class B modulator stage. At the present time 845's are about all that can be used.

And now what with all the fuss the minority report has aroused it looks as though there might be an "investigation of the investigation committee".

Ouchtube is a town in Russia—QRA of the h.f. commercial, RDF.

Make This OSCILLOSCOPE

Low cost, easily constructed kit for amateurs and experimenters. With it view and demonstrate wave form! Use for making resonance and r.f. indicators and audio oscillators. Comes with a new and brilliant tube having long life. Unexcelled fidelity response. Now better adapted to r.f. operation. Definition of wave form clean-cut and clear. Order now at this low price.

COMPLETE KIT

\$2.00 Net

Prepaid with Improved Tube, Clips, Mirror and Motor Shaft Adapter.

TUBE ONLY \$1.50

See at your jobber or order direct

SUNDT ENGINEERING CO.

4236 LINCOLN AVE.

CHICAGO, ILL.

(Affiliate of Littelfuse Labs. Makers of Instrument Fuses—Radio and Auto Fuses—High Voltage Fuses—Aircraft Fuses—Fuse Mountings—Neon Potential Fuses and Indicators.)



THE KIT!

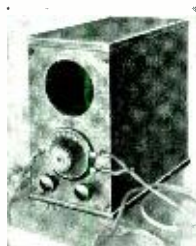

WHEN FINISHED!

THE DECKER COIL AND LINK

A LOW-LOSS WIRE COIL THAT TAKES A KILOWATT AND LIKES IT!

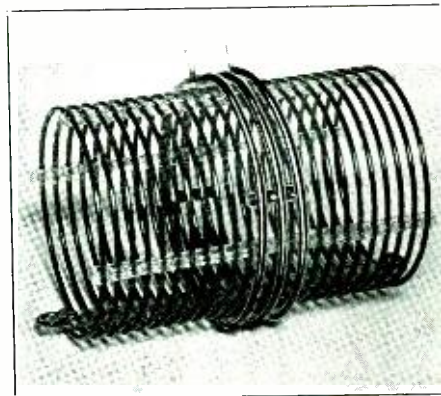

The final important improvement in "wound-on-air" wire coils has been achieved. The unavoidable mechanical weakness of copper wire has been overcome.

The new series "B" Decker Coil is made of a special high carbon steel-core wire. The Series "B" not only "Takes a kilowatt and likes it", but also smiles at mechanical abuse.

The electrical efficiency remains the same and the strength is increased enormously by the steel core.

Band	Coil	Series "A"	Series "B"
160	Final	\$4.15	\$6.25
80	Final	3.30	5.00
40	Final	2.90	4.40
20	Final	2.50	3.75
10	Final	2.10	3.00
All Bands	Link	1.50	2.50

Above prices are list

40% discount extended licensed amateurs

When ordering, send us a diagram of the circuit for which you want the coil. Be sure to note the capacity of the condenser with which you intend to tune. We have a large selection of inductances in each band. WE SEND YOU THE CORRECT COIL TO RESONATE IN YOUR CIRCUIT.

The supporting material is fire-resistant and cannot be ignited from a soldering iron. This makes tapping easy, or, if requested, we do your tapping for you.

If your dealer cannot supply you order direct.

DECKER MFG. CO.

SOUTH PASADENA, CALIF.

What's New

New National High Frequency Tube

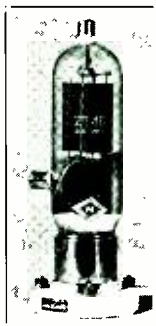

The National Radio Tube Co. has added to their line a type ZT-4B, a high μ "100 watt" with plate and grid leads brought out directly through the glass envelope to cut down inter-electrode capacities. In spite of the high μ , the tube has a very moderate plate resistance, and good output and efficiency are obtainable at comparatively low plate voltage. The maximum ratings (good up to 15 megacycles) are: plate voltage, 1250; plate current, 300 ma.; grid current, 60 ma.; plate dissipation,

100 watts. The tube may be used at much higher frequencies at reduced ratings. The filament draws 4 amps. at 10 volts.

Tube Pamphlet

United Electronics has released a four-page pamphlet devoted exclusively to their new Svea metal mercury rectifiers, giving all characteristics of their types 966, 966-A, 972, and 972-A. The pamphlet is available on request.

New R.C.A. Tubes

804

The RCA-804 is a transmitting pentode intermediate to the 802 and 803, and resembling somewhat the Raytheon RK-20 in characteristics. It has a rating of 40 watts maximum plate loss for class C service, and can be operated at maximum ratings for frequencies as high as 15 megacycles. It may be used as either a plate-modulated, suppressor-modulated, or control-grid-modulated r.f. amplifier. The filament draws 3 amps. at 7.5 volts, and maximum plate voltage rating is 1250 volts. The plate lead is brought out the top of the envelope. The other leads are brought out a standard five-pin base.

805

The RCA-805 is a high μ transmitting triode with the plate lead brought out the top of envelope. It may be considered as an "improved 838". It may be used as either an r.f. amplifier or oscillator, or as a class B modulator (2 tubes). The tube was designed to have a μ that varied somewhat with input signal. This allows a class B audio stage with very low distortion.

The tube may be run at 1250 volts in a modulator stage with zero bias. The output under these conditions will be in the neighborhood of 300 watts at 4% harmonic distortion (assuming good amplifier design). At 1500 volts, with 16 volts negative bias, a pair will turn out 370 watts of audio at approximately 3% harmonic distortion.

The 805 may be used at maximum ratings as an r.f. amplifier up to 30 megacycles. The maximum allowable plate dissipation in class C service is 125 watts.

836

The RCA-836 is a half-wave, high-vacuum rectifier for use where, due to temperature encountered or necessity for absence of "receiver hash", the 866 mercury rectifier is not satisfactory. The voltage drop is very low due to close spacing between the cathode and anode (compare 83-v to the type 83). The filament requirements are the same as for the 866. The peak current rating is greater (1 amp.) but the maximum allowable peak inverse voltage is less (5000 instead of 7500 as for the 866). The type 836 will "stand the gaff" better than the 866 in condenser-input type filters, especially where the input condenser is of large capacity and over 150 ma. of plate current is drawn from the filter. The cathode heater should be allowed to reach operating temperature (about 40 seconds) before the plate voltage is applied.

New Amateur Superhet

At this writing, early in March, our sample of the ACR-175 receiver has not yet arrived from the R.C.A. Manufacturing Co. for test in the RADIO laboratory. However, we have seen the set and offer the following general description.

The receiver is an all-wave superheterodyne with certain additions to facilitate its use in 2-way communication. Like most recent receivers it has tone control, built-in power supply, automatic volume

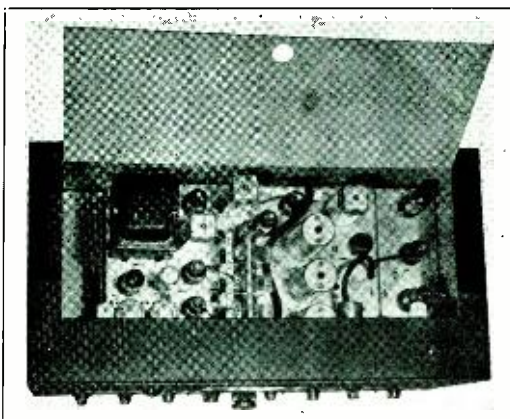

A "look inside" the new R.C.A. type ACR-175 superheterodyne. Metal tubes are used throughout, excepting the 6E5 tuning indicator.

control, 2-speed dial drive, and a range-selecting switch. Eleven metal tubes are used, including the 6L7-6J7 combination, whose usefulness has been mentioned several times before. Like many new sets this one has had its range extended down to 5 meters. It also goes up to 600 meters, in 4 ranges.

The dial system combines ease of tuning with ease of recording. As either the low-speed or high-speed knob is turned the main pointer moves across a conventional tuning scale. At the same time a vernier pointer moves much faster, making one com-



plete circuit of its private 100-division scale per main-scale division. Thus the main scale can be read to 1/100 division, which is more than sufficient precision. The controls are placed low for convenience. A conventional phone jack is provided for headphone reception.

On the Atlantic seaboard, interference from commercial c.w. and i.c.w. stations is so common that both broadcast listeners and those doing 2-way communication will be intrigued by the 460 kc. antenna-circuit wavetrap of the ACR-175, additional to which is provided a tuned pre-selector stage effective on 3 of the 4 ranges.

Several features will appeal especially to the transmitting amateur. Among these is the independently mounted speaker and the green panel light which is on when the receiver is "warmed up" but the tubes are without plate voltage because the send-receive switch is in the "send" position. The customary "R" meter is replaced by a combination of a 6E5 "magic eye" and a sensitivity control calibrated in approximate signal-input microvolts. The control is turned until the "eye" just starts to operate; then the signal strength is read from the scale of the control.

Claims made for the receiver are exceptional stability, signal-to-noise ratio, and sensitivity; also improved crystal-filter action due to a special crystal.



BOOK REVIEW

High Frequency Text

PHENOMENA IN HIGH-FREQUENCY SYSTEMS, by August Hund. This text of over 600 pages covers the principles and fundamental laws pertaining to all branches of high frequency systems. It makes a fine reference book for students, teachers, and research engineers. The entire book deals with high frequency theory and associated subjects, and no attempt is made to describe practical working models or apparatus. For this reason the theory is more complete than in most text books and fills a gap in radio literature.

The chapter on networks and filter circuits is more complete than most books on those subjects and the chapters on antennas are quite interesting technically. All forms of high frequency generators and amplifiers are covered.

This book sells for \$6.00 and is published by the McGraw-Hill Book Co.

Engineer's Handbook

RADIO ENGINEERING HANDBOOK, second edition, by Keith Henney. This handbook of over 800 pages is the result of the efforts of 28 engineers and physicists, the whole being correlated by Keith Henney. Each section has been written by a specialist in that field, for example: Messrs. A. Hoyt Taylor and one of RADIO's editorial staff, Robert Kruse, writing the section on "High Frequency Transmission and Reception". This handbook is especially suitable for radio technicians and students because emphasis has been placed on modern radio practice rather than the-

ory. Besides all branches of the radio field, sections are devoted to television, photo cells and sound motion pictures.

Looking over the list of names of the authors of each section is like reading "who's who" in the radio engineering field. Certainly those near or at the top of their profession were chosen to handle the sections concerning their particular fields of endeavor. The handbook sells for \$5.00 and is a publication of the McGraw-Hill Book Co.

OK1BC informed W7AMX of working all continents on 28 mc. in 5 hours 20 minutes!

THE IDEAL COMPANION

to Your Big Super-Het

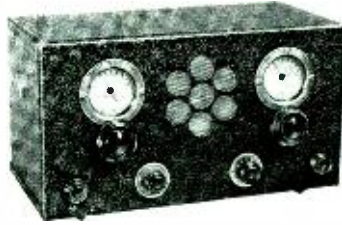

EMERGENCY Wave Coverage—

The advanced amateur prides himself on the completeness of his equipment. The outstanding public

service rendered by amateurs throughout the nation . . . in times of extreme emergency, has built a world-wide reputation for the American HAM.

The complete . . . prepared for any emergency, amateur station has facilities for covering wave bands other than the ordinary "short waves".

• **Sargent 10-CA Ideal Stand-by Receiver**—Covers commercial tuning range, no skips, no dead spots. Complete compact, the Sargent 10-CA is so flexible and easy to handle, so sensitive and quiet, many owners prefer it to the large receiver.

AMATEUR NET PRICES

Tubes and Speaker included

Model 10-CA, 15-3750 Meters, Complete.....\$47.50

Model 10-MA, 15-1500 Meters, Complete..... 39.50

Model 10-SA, 15-5500 Meters, Complete..... 34.50

We Use and Recommend RCA Tubes

D, C. and Battery Prices on Request.

IMMEDIATE DELIVERY.

E. M. SARGENT COMPANY

212 NINTH ST.

DEPT. R

OAKLAND, CALIF.

Special Radio Services by Robert S. Kruse, E.E.

—For the Professional:

Apparatus and station designs and improvements.

Construction of special apparatus.

Problems involving cathode ray equipment.

—For the Amateur:

High-grade discontinued commercial transmitting equipment.

"The Answer Factory," a low-cost information service on operating and constructional problems.

Quotations on request.

ROBERT S. KRUSE
GUILFORD, CONNECTICUT
(Near New Haven)



Osockme, Japan,
March, 1936.

Hon. Ed. of Glass Drilling Dept.
of "RADIO", Page 89 Feb. Issue.
Dear Ed:

Yippie! Scratchi have just successfully succeed in passing examinations for special fone lisense. Radio shack here are now plastered up with handshaking QSL cards from amateur brothers and half-brothers who send SWL cards. Scratchi make long and hard ponderings over what are meanings of SWL and upon written requests to local Japanese newspaper inquiring department I are informed that such are abbreviation from full-fledged word meaning swill. Only the *i* and the *l* are omitted from such to save two letters of type when printer print WSL cards and usual 40% discounts off are thus given to SWL card customers because two letters are taken from five

letter word which result in 40% off. Such are easy to understand if one are in possessions of sliding rule or not.

Scratchi are also saving penny-yen coins in large bucket for which it are desire to sometime make purchase of entry into W.A.C. It are harder for Scratchi to save such money for stiff-ticket than it are to work W.A.C. Scratchi are profound believer in fax that increase in W.A.C. membership would become hundred persense and more if costs were reduced in half part because many brothers of rising sun here in Japan have been forced to pool large resources so that purchase can be make of one W.A.C. honor skrool and it are further necessary to pass such ticket out among all amateur here so that each who help contribute to cost of purchase of same can enjoy few days use of such in each change of the Japanese moon. Friendly slick-hat politician come make visit to Scratchi abode and see much W.A.C. stiffticket hang over large knothole in plastered wall and ask inquiry what come such from and for what and what cost. To which Scratchi reply with scornful clatter of boot spurs that such are honor award which cost but two yen fifty American depressed funds with tax included and such awards are made only upon payment of such sums. If such sums are not available, poor ham are forced to forge his own W.A.C. certificate with name of Wenneth B. Korner on bottom side.

I now ask of hon. Editor, kind sir, would you make reply please and inform Scratchi what happen if ham make W.A.C. all day long, five times each day, and want W.A.C. certificate but have no \$2.50 to pay for such. I emploere of you, Hon. Ed. that you print ticket for ham loving hams for fractions of such price, because printer here in Japan who do racketeering on side inform me that for two bucks fifty he can print several hundred such ornaments and with more gold eagles and ducks and seagulls on such on larger paper sheets which would make every amateur gice with joy.

I are kindly sole, Hon. Ed., but I are getting off of tracks from what I first make intention of write you. I may enjoy last previous issue of Hon. sheet RADIO and get full enjoyment from artikel which show how to drill hole in glass pieces with 3-corner file.



CHICAGO MORRISON HOTEL
In the Heart of the Loop
SINGLE ROOM **\$2.50** UP
\$4.00 Double
Each, with Bath, Servidor
and Circulating Ice-Water
LEONARD HICKS
Managing Director

the . . . MICROMETER FREQUENCY METER is furnished with a fundamental-frequency range of 5000-6000 KC. It is especially valuable for checking receivers and transmitters in the ultra-high frequency region, above 25,000 KC.

RUGGED, DEPENDABLE and ACCURATE

for

Ultra

High

Freq-

uencies

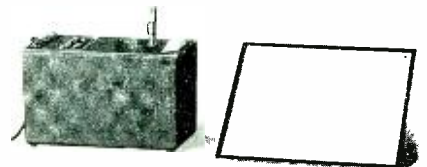

LAMPKIN LABORATORIES

Bradenton, Fla.

Scratchi find such artikel most educational and I have already make succeed in taking four diamonds, two wristy watches, one alarm clocks, store safe and neon sign from out of local Japanese Jewelry store window because of knowledge which such glass hole punching artikel have taught Scratchi in such short time. It are quite easy to drill large hole in store windows with such information as RADIO now bring forth, and Scratchi find his complimentary subscription more valuable than evermore with thanks to you, Hon. Ed. for my enrichments.

It are with profound regrets that Scratchi bring this letter to quick stop because I read from daily paper that Scratchi finger prints are found on joolry store window and it seem to Scratchi that loud clump and thud of detective footprints are make heard coming down chimney pipe with warrants for arrest for your Hon. contributor. I are hastily preparing alibi to give to such persons by inform him that Scratchi make only experiment in glass window pain for purpose of running free antenna wire into joolry store so watchmaker can get daily time-tick for clock-settings and such. If alibi are not prove successful, Hon. Ed., my return address for next letter are from county jail from where I will keep you inform.

Your bungled servant,

HASHAFAISTI SCRATCHI.

Roy Hunt, W6CNE, using the 50 watt all band transmitter described by Ralph Gordon in January RADIO, has received confirmation of his five meter *phone* signals being heard in Cleveland, Ohio; Oakland, California; Springfield, Massachusetts; and Florida. Evidently crystal control a good location, and a good antenna are responsible for this excellent work.

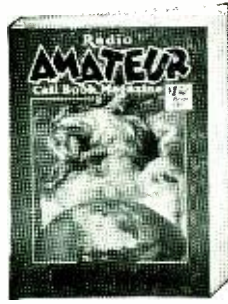

The Most Complete Callbook Ever Published

Your QRA is listed in the latest edition

The only radio callbook published that lists all radio amateur stations throughout the entire World.

Also a complete list of high frequency commercial stations, International abbreviations and amateur prefixes, "Q, R, & T," systems for reporting signals, new US inspection districts and high frequency time, press and weather schedules.

Each copy contains a double post card addressed to the CALLBOOK for use in reporting your new QRA. We are extremely anxious to publish a callbook that will be 100% correct and want you to help us by checking your QRA at once in the latest edition and advise us of any errors.

PUBLISHED QUARTERLY MARCH, JUNE, SEPTEMBER AND DECEMBER

Single Copies \$1.25 Annual Subscription USA, \$4.00

Order your copy today from your local radio jobber or direct from:

RADIO AMATEUR CALL BOOK, Inc.
606 South Dearborn Street, Chicago, Illinois



Many new charts, tables, formulae, diagrams. Hundreds of illustrations.



MAIL COUPON BELOW

Greatest of All Radio Books

The 1936 edition of "THE RADIO HANDBOOK" eclipses all others in its amazing content. Tells how to build any kind of a receiver, from a one-tuber to a de luxe crystal-filter superhet. How to build ANY kind of a c.w. or phone transmitter from a one-tuber to a full kilowatt. Revolutionary data on new antenna systems for all-band operation. New grid-bias controlled carrier phones. Complete 10-meter chapter. All the new 2 1/2 and 5-meter information. Truly the book of books.

ALMOST 400 PAGES

ONLY ONE DOLLAR PER COPY

RADIO Magazine,
7460 Beverly Blvd.,
Los Angeles, Calif.

Please send me postpaid a copy of the 1936 "RADIO" Handbook, published by the Pacific Radio Publishing Co. I have enclosed \$1.00 and am expecting a lot for my money.

Name.....Call.....
Street and Number.....City and State.....



BUYER'S GUIDE

Where to Buy It

CALIFORNIA—Fresno

Ports Manufacturing Co.
3265 E. Belmont Ave. Radio W6AVV
National FB7-SW3 and Parts; Hammarlund, Cardwell, Bliley Crystals; Johnson Insulators Distributors RCA-DeForest Transmitting Tubes
Established 1914 Send for Wholesale Catalog

CALIFORNIA—Los Angeles

Radio Supply Company
912 So. Broadway

THE AMATEURS' HEADQUARTERS OF
THE WEST

All Nationally Advertised Parts for Receiving and Transmitting Carried in Stock at All Times. 9 Licensed Amateurs on Our Staff.

CALIFORNIA—Oakland

Radio Supply Company
2085 BROADWAY

Hammarlund, Yaxley, Carter, National, Johnson, IRC, Cardwell, Miller, Morrill, Flechtheim, Triplett, Haigis Transceivers.
W6GFY

CALIFORNIA—San Francisco



1452 Market Street

"The House of a Million Radio Parts"

Hammarlund and National sets and parts
RCA and EIMAC Tubes.
Arcturus Receiving Tubes.
Trimm Phones, all types.
Johnson Antenna Feeders, Insulators,
Transposition Blocks.

ILLINOIS—Chicago

CHICAGO RADIO
APPARATUS CO., Inc.
Established 1921

415 SOUTH DEARBORN STREET
(Near Van Buren Street)

ALL SUPPLIES FOR THE SHORT
WAVE FAN AND RADIO AMATEUR
QUOTATIONS FREELY GIVEN ON
ANY KIT OR LAYOUT

Short Wave Receivers Taken in Trade
Get our low prices

PARTS REQUIRED FOR BUILDING EQUIPMENT SHOWN IN THIS ISSUE

The parts listed are the components of the models built by the author or by "Radio's" Laboratory staff. Other parts of equal merit and equivalent electrical characteristics may usually be substituted without materially affecting the performance of the unit.

50-T Controlled Carrier

C1, C2, C13, C14, C15—Hammarlund Star Midgets
C16—Cardwell XT-80-PD
CH2—Thordarson T-5450
CH3—Same, T-6409
T1—Gardner F-03A
T2, T6—Thordarson T-6421
T4—United Transformer CS-47
T5—Gardner 2150
T7—Gardner 8664
T8—Thordarson T-6773

Gonsett Diathermy

C1—Sangamo
C2—Cardwell MT-100-GS
T1—Inca 4414
T2—United Transformer PA-116
Pads—Special. Radio Television Supply Co.
RFC—Hammarlund CH-8

10 Meter Phone-C.W.

T1—United Transformer CS-5
T2—Same, CS-29
C1, C4, C9—Hammarlund star
C12—Cardwell XT-80-PD

CHICAGO—Illinois

Mid-West Radio Mart
520 South State Street
Rex L. Munger, W9LIP, Manager
America's Amateur Headquarters

ILLINOIS—Chicago

NEWARK ELECTRIC CO.
226 WEST MADISON STREET

The Best at Lowest Prices—Write for
Complete Catalog

NEW MEXICO—Albuquerque

WM. H. ALLEN CO.
BOX 641
DISTRIBUTORS OF NATIONALLY
ADVERTISED RADIO

NEW YORK, N. Y. 227 FULTON ST.



Complete Stock of Amateur Radio Supplies
at Wholesale Discounts

PENNSYLVANIA—Philadelphia

M & H Sporting Goods
Company
512 Market Street

PENNSYLVANIA—Pittsburgh

CAMERADIO COMPANY
603 GRANT STREET

WASHINGTON—Spokane

Spokane Radio Co., Inc.
611 First Avenue

The Marketplace

(a) Commercial rate: 10c per word, cash with order; minimum, \$1.00. Capitals: 13c per word. For consecutive advertising, 15% discount for 3rd, 4th, and 5th insertions; 25% thereafter. Break in continuity restores full rate. Copy may be changed often as desired.

(b) Non-commercial rate: 5c per word, cash with order; minimum, 50c. Available only to licensed amateurs not trading for profit; our judgment as to character of advertisement must be accepted as final.

(c) Closing date (for classified forms only): 25th of month; e.g., forms for March issue, published in February, close January 25th.

(d) No display permitted except capitals.

(e) Used, reclaimed, defective, surplus, and like material must be so described.

(f) Ads not relating to radio or radiomen are acceptable but will be grouped separately.

(g) No commissions nor further discounts allowed. No proofs, free copies, nor reprints sent.

(h) Send all Marketplace ads direct to Los Angeles accompanied by remittance in full payable to the order of Radio, Ltd.

(i) We reserve the right to reject part or all of any ad without assigning reasons therefore. Rates and conditions are subject to change without notice.

WHEN you don't know what to build it in, see R. H. Lynch, 970 Camulos, Los Angeles. Steel cabinets and racks, aluminum cans, panels. Special sizes to order. Send for circulars.

W9MPB may write for free Handbook.

SPECIAL "ultra-de-luxe" copies of the 1936 "RADIO HANDBOOK", bound with Vellum Cloth, front cover and back-bone stamped in imitation gold. These "ultra-de-luxe" handbooks are printed on heavy, coated enameled paper, bound like a regular text book. A magnificent job. Price \$2.50, prepaid. Pacific Radio Publishing Co., Pacific Bldg., San Francisco, Cal.

A free Handbook to W5ACP.

GUARANTEED TRANSFORMERS and chokes. Power supplies, modulation equipment, microphones, amplifiers, preamplifiers, etc. Universal class B transformers. 100 watts, pair \$8.00. Racks and panels, all sizes. Amerec tubes. Langrick Radio Engineering Service. W6PT, 626 Maltman Avenue, Los Angeles.

One Handbook free to W1CQR.

SELL: 852's, 1 Kw. Transformer. Crystals, Holders, Old UV202's, 50 watt, Generator, 300 miscellaneous parts. Illustrated list. Lane Jackson, Independence, Missouri.

One Handbook free to W6CCJ.

SELLING OUT: Transmitting tubes, transformers, 1000 v. Edison "R", mounted crystals, holders, blanks, SW's, 300 Miscellaneous parts. Illustrated list. Lane Jackson, Independence, Mo.

TRANSFORMERS REWOUND and built to specifications. Very best quality materials and workmanship. Ecoff Transformer Co., 1929 Forest Ave., St. Louis.

QSL's, SWL's-Cards. Finest quality stock. Very attractive. Photo type. Different. Very reasonable. Samples? (Stamps). RADIO-PRESS-W8ESN, 182¹/₂ Cone St., Toledo, Ohio.

To W8JLZ a free Handbook.

SPECIAL 866B's, 2.5 volt, 9 amp. filament, 1200 mil. peak current. \$3.75. Regular 866's, \$1.65. Universal class "B" transformers, \$8.00 pair. W6PT, Langrick Radio Engineering Service, 626 Maltman Ave., Los Angeles, Calif.

DIATHERMY machine described in this issue, complete with pads but without tubes, for approximate cost of parts. Requires two 50-T and two 866. Shipped express collect. Price: \$47.50. California add tax. "RADIO", 7460 Beverly Blvd., Los Angeles.

WANTED: Old radio sets or parts for ham antique collection. All letters answered. W6LM.

RACKS, cabinets, shield cans. Send for circulars. R. H. Lynch, 970 Camulos, Los Angeles, Calif.

A free Handbook to W9SPL.

GENERAL ELECTRIC dynamotors 24/750 volts, 200 mils., \$25.00. Two for 1500 volts \$40.00. Westinghouse 27/350 \$10.00. 500 Watt, 500 cycles, \$10.00. List. Harry Kienzie, 215 Hart Blvd., Staten Island, New York.

NEON TUBES, four inches, for RF testing, Oscilloscopes, special lengths made to order. Postpaid (U. S., Canada) \$3.00. W8AXB, GLOMU SPECIALTIES, 3411 Harrison Avenue, Cheviot, Ohio, Dept. B.

SELL one "20-40" receiver shown in 1936 "Radio Handbook", page 53, complete with tubes, crystal, but less power supply, \$39.00. 5 meter super in metal cabinet, page 232 of the "handbook", complete with tubes, \$29.00. Frank C. Jones, 2037 Durant Ave., Berkeley, Calif.

COMPLETE 1935 volume "RADIO", January to December. Several on hand, \$3.00, postpaid. Pacific Radio Pub. Co., 422 Pacific Bldg., San Francisco, Calif.

DANGER! High voltage card (red and blue), 10c; CALL-BOOKS, \$1.25. Bliley 14 mc. crystal, \$7.50. W8DEB, Holland, Mich.

FOR SALE: One Westinghouse 500 volt d.c. motor generator set in good condition, \$18.00. Motor is 110 volts a.c. W9CDE.

QSL SWL Cards, neat, attractive, reasonable. Samples free. Miller, Printer, Ambler, Pa.

METERS: New and used Weston, Jewell meters at bargain prices. All types, perfect condition, individually checked. Free bulletin. W2EDW, Far Rockaway, New York.

SHIELD CANS, 7 x 10 x 6 1/4". Steel, crackle finished. Removable panel and deck. Hinged lid. \$2.20. Six pounds. R. H. Lynch, 970 Camulos, Los Angeles, Calif.

CASCADE MODULATED 210 TRANSMITTER described in this issue by Martin Brown. Sell for approximate net cost of parts, \$80 F.O.B. Los Angeles. Price includes 80 meter coils but less microphone, tubes, meter, and crystal. This includes power supply unit, modulator and speech unit, and radio frequency unit. RADIO, 7460 Beverly Blvd., Los Angeles.

TRANSFORMERS, chokes, all types. Reasonable. Guaranteed. Special universal class B inputs and outputs 100 watts audio—pair \$8.00. California Radio Labs., W6CYQ, 2525 South Hill Street, Los Angeles.

W8BDA may write for free Handbook.

FINE QSL's! SWL's! Samples. W9UIH Press, 2009 Fremont Street, Chicago.

QSL's, 300 one-color cards \$1.00. Samples. 2143 Indiana Avenue, Columbus, Ohio.

NATIONAL AGSX receiver. Full set A, B, C, D, and E coils. Rack mounting, power supply, permanent magnet speaker, \$95 f.o.b. Remler condenser microphone, special "homb" amplifier. A beauty, perfect condition, \$35.00. W6APU, 428 No. Maple Drive, Beverly Hills, Calif.

SELOUT: Complete station comprising 500 watt remote controlled transmitter, rack mounted, 345 final; frequency-meter-monitor; modified FBX with regenerative preselector; EO-1 cable; insulated guys; boxes of spare C's, R's, etc. \$345 f.o.b. Honolulu. Capt. R. E. Pirtle, Wheeler Field, Oahu, T.H.

MAKE OFFER: 300 watt 14 mc. c.w. xmitter, \$45. Silver 5B Super, \$40. Bug, \$5. 6000 v. xmitting condenser \$5. N.R.I. radio course, \$30. 56 Mc. 19 watt phone xmitter and 4 tube receiver, \$25. W8ITA, Washington, Pa.

WANTED: Edison storage "A" batteries, UX852s. Grote Reber, Wheaton, Illinois.

LARGE STOCK new and used equipment for sale by Southern Ohio's only amateur owned amateur business—Jos. N. Davies, Box 602, R.R. 9, North Bend Rd., Mt. Airy, Cincinnati, Ohio.

75-160 DE LUXE PHONE TRANSMITTER, complete. Uses 2A5 into 210 into two Sylvania carbon plate 210's, 75 watts input. Continental two-button mike with desk stand. Speech: 56, 56, 2A3's, 46's class B. Factory built metal racks (two) complete with dust covers: 14 inches wide, 19 high. National dials, 4 Triplet meters. Complete, ready to operate including 75-160 coils, 160 crystal, all tubes and mike. Parts alone cost \$175 net. Will sell \$125 F.O.B. Has very good quality and delivers a good "sock". W6VR, 902 So. Cloverdale, Los Angeles.

CRYSTALS: SATISFACTION OR MONEY BACK. 160-80 meters within 10 kilocycles Y-cut \$1. X-cut \$1.35. Wright Laboratory, 3859 Glenwood, Chicago, Ill.

WE have our PR-16 and can make deliveries. Used sets and parts. List Free. W9OC, Spencer, Iowa.

SUPER-SIGNAL, the new crystal supreme, \$5.00. Information on request. Also V, AT, and X at popular prices. W1BD.

To W9MYV a free Handbook.

FOR SALE: Metal Tube Super-Gainer described in March RADIO complete with tubes and 10 and 40 meter coils, \$20.00. Relay rack 30 watt controlled carrier phone, 120 watt c.w. set. Uses pair of RK20's in final amplifier driven by two 53's. Complete with 80 meter coils, built-in power supply, tubes, and \$50 broadcast type carbon mike. Sell for \$160. Frank C. Jones, 2037 Durant Ave., Berkeley, Calif.



*Most Complete Transformer
Line in the World*

QUALITY · RELIABILITY

Sure ... **UTC Transmitter Kits**
are available complete
with matched antenna
tuning assemblies and
**ARF Cathode Ray
Oscilloscope panels..**



30 Watt Speech Amplifier and Modulator Section.
Fully Mounted with Removable Dust Cover.

**The 50 AC Antenna
Tuning Assembly**

Maximum energy transfer is obtained with this unit which consists of two variable capacitors, a changeover switch and a 0-2.5 ampere thermo couple ammeter. This rack assembly is 19 inches wide and 8 3/4 inches high and is supplied completely mounted ready to wire. This unit is designed for the 50 watt series only.

**The ARF Cathode Ray
Oscilloscope Panel**

This unit provides a positive means of checking neutralization, peak voltages, % of modulation, etc . . . Trapezoidal and Envelope patterns are available. It is mounted on an overlaid etched metal 19 inch panel and furnished with a cover which shields the unit from dust and stray fields.

**The 500 Watt Input Carrier
Control Class B Linear Stage**

Consists of a Class B Linear push pull 852 power stage, a high voltage 866A power supply and a C bias supply of exceptionally good regulation. Link coupling provided between the exciter and the 852 Linear Stage. The amplifier is supplied with two cabinets of the type shown on facing page. The 852 Linear Amplifier may be added to the 50 watt Control Carrier rig at a later date.

**500 AL Antenna Tuning
Unit for Class B Linear Stage**

Consists of a low loss antenna matching network made up of two inductors, two capacitors and a sensitive RF thermo couple ammeter, all mounted on a standard 19 inch rack assembly.

Exclusive U.T.C. Distributors carrying a complete stock of U.T.C. Products

Harvey's Radio 105 W. 43rd St., New York, N. Y.
Goldhamer's, Inc. 610 Huron Road, Cleveland, Ohio
Wholesale Radio Service Co. 100 Sixth Avenue, New York, N. Y.
Wholesale Radio Service Co. 219 Central Ave., Newark, N. J.
Wholesale Radio Service Co. 430 W. Peachtree St., N.W., Atlanta, Ga.
Wholesale Radio Service Co. 911 Jackson Blvd., Chicago, Ill.
Wholesale Radio Service Co. 542 East Fordham Rd., Bronx, N. Y.
Sun Radio 227 Fulton St., New York, N. Y.
Gross Radio, Inc. 51 Vesey St., New York, N. Y.
Leeds 45 Vesey St., New York, N. Y.
Mohawk Electric Co. 1535 State St., Schenectady, N. Y.
Walter Ashe 1100 Pine St., St. Louis, Mo.
Radio Shack 46 Brattle St., Boston, Mass.
Hatry and Young New Haven and Hartford, Conn.
Marine Radio Co. 124-13 101st Ave., Richmond Hill, N. Y.
Fillin et Radio 5 Rue Denis Poisson, Paris, France
Hall's 35 So. Cameron, Harrisburgh, Pa.
Herbach & Rademan 438 Market St., Philadelphia, Pa.
Radio Electric Service 7th and Arch Sts., Philadelphia, Pa.
Cameradio Company 603 Grant St., Pittsburgh, Pa.
W. H. Edwards & Co. 32 Broadway, Providence, R. I.
Seattle Radio Supply, Inc. 2319 Second Ave., Seattle, Wash.

San Francisco Radio Exchange 1284 Market St., San Fran., Calif.
Straus Frank Co. San Antonio, Texas
Straus Frank Co. Houston, Texas
Rissi Brothers 5027 Hamilton Ave., Detroit, Mich.
Amateur Radio Equipment 138 East Butler Ave., Memphis, Tenn.
Northeastern Radio 281 Columbus Ave., Boston, Mass.
Springfield Radio 397 Dwight St., Springfield, Mass.
Kraus & Co. 89 Broadway, Providence, R. I.
Braid Electric Co. 107 Ninth Ave., Nashville, Tenn.
Wisconsin Radio Supply 434 W. 8th St., Milwaukee, Wis.
Bruce Company 206 E. Monroe, Springfield, Ill.
Beucaire Company 228 Broadway, Rochester, N. Y.
Dallas Electric Supply Co. Dallas, Texas
Peterson Lumber & Supply Co. El Paso, Texas
South West Radio Supply Co. 107 South St. Paul St., Dallas, Texas

SOUTHERN CALIFORNIA

Pacific Radio Exchange, Inc. 729 S. Main St., Los Angeles
Radio Supply Co. 912 S. Broadway, Los Angeles
Radio Television Supply Co. 1701 S. Grand Ave., Los Angeles
Radio Specialties Co. 1816 W. 8th St., Los Angeles
Zack Radio Co. 1000 S. Broadway, Los Angeles

Will *You* win this transmitter

Phone and CW KIT, FULLY MOUNTED . . . *Ready-to-Wire*

● Variactor Carrier Control modulation is now being used by many amateurs in their own phone rigs. These new Ready to Wire transmitter kits employ the Variactor system exclusively. A 50 watt kit in cabinet (illustrated at right) will be given away free to the amateur who suggests a name that will best describe this series of transmitter kits using Variactor Carrier Control.

● Contest closes July 1st, 1936. Judges are: Frank Jones and L. M. Cockaday, two nationally known radio editors. Mail suggested names direct to UTC.

● These new units represent the last word in transmitter KIT design. Nothing has been overlooked to obtain maximum performance and efficiency, and yet the kits are PRICED WITHIN REACH OF EVERY AMATEUR.

● A list of the manufacturers whose parts are used in these assemblies reads like the blue book of Ham Radio: UTC, Cardwell, Cornell Dubilier, Hammarlund, Isolantite, Aerovox, IRC, Triplett, Yaxley, Johnson, Electrad, etc. . . . Tubes by RCA.

● The units are furnished completely assembled and mounted on black enamel chassis with front rack panels and etched metal overlay plates. All you have to do is wire them . . . even the wire is furnished. Full working prints accompany each assembly.

● Begin with a 50 watt CW unit and later use it to excite a 750 watt CW Class B Linear Stage or start with the 50 watt VARIATOR controlled carrier phone rig and use it later to excite a 500 watt Phone Class B Linear Stage. Units may be purchased separately and are complete in themselves.

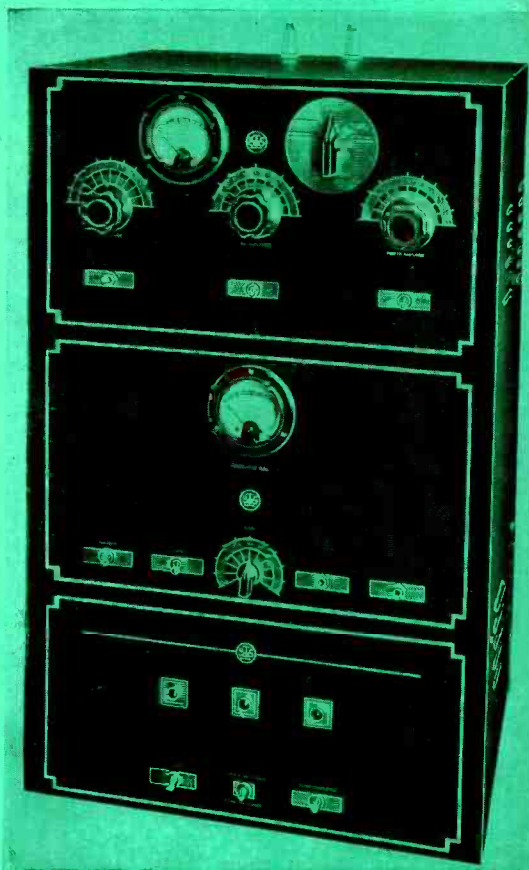

COMPLETE ASSEMBLY OF THE THREE UNITS

Full Scale Working Print Brochure covering all constructional plans for the 50 watt, 500 watt and 750 watt units may be purchased from your distributor or direct for 25c. Free with purchase of each sectional unit.

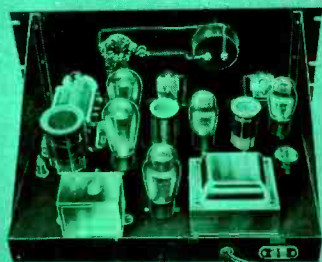

Section One

50 watt RF unit. Consists of Crystal-controlled pentode oscillator, pentode buffer-doubler, push pull final amplifier, and choke input mercury vapor rectifier system having a regulation better than 5%, readings on 5 circuits instantaneously through one meter. Used by itself this unit is a highly efficient 50 watt CW transmitter.

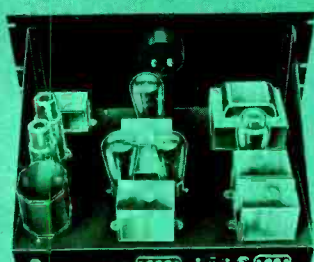

Section Two

Consists of a high gain speech amplifier and Class B modulating stage. It has an output of 30 watts, and when used to modulate the RF amplifier at 100% modulation the distortion level is less than 5%. This amplifier is designed for use with high level crystal microphones and will operate with any of the carbon type.



Section Three

VARIATOR Controlled Carrier Unit. Has a separate power supply for 50 watt class C stage and Variactor units for carrier control. Instantaneous switch-over provided from carrier control to constant carrier. When used with 500 watt class B Linear stage DX coverage is increased, efficiency of the Linear stage is easily doubled. Reduces interference between stations tremendously.

UNITED TRANSFORMER CORP.

72 SPRING STREET

NEW YORK, N. Y.

EXPORT DIVISION - 15 LAIGHT STREET, NEW YORK, N. Y.

RCA proudly presents the ACR-175

This new RCA amateur receiver incorporates every desirable feature of design, construction and operation, including several remarkable new developments.



\$119⁵⁰
net
f. o. b. factory

Translate these features into performance

1. 5 to 600 meters, continuous
2. Ultra-selective crystal filter
3. "Magic Eye" tuning and signal strength indicator
4. Actual signal input read directly in microvolts
5. Iron Core i-f Transformers (permanent alignment, high gain)
6. Metal Tubes
7. 11 tubes, 2 I. F. stages
8. Increased sensitivity
9. Greater selectivity with or without crystal
10. Improved signal-to-noise ratio
11. Improved a. v. c.
12. Greater band spread
13. Separate dynamic speaker
14. Pre-selection
15. Band change by switch
16. Individual coils for each band
17. Unusual stability
18. Iron-core heterodyne oscillator calibrated in cycles
19. Audio tone control
20. Unique stand-by pilot light
21. Handsome, rugged metal cabinet
22. Improved velvet drive tuning control—no back lash
23. Direct-reading, calibrated dial
24. Single-control tuning
25. Convenient and accurate logging
26. Two-speed, positive dial drive
27. All controls on front panel
28. Controls conveniently located low on panel
29. Headphone jack
30. Built-in power supply
31. Power transformer operates on 25 to 60 cycles
32. And the price, complete with tubes, crystal, speaker—only \$119.50 net, f. o. b. factory

Available for immediate delivery

AMATEUR RADIO SECTION

RCA MANUFACTURING COMPANY, INC.

CAMDEN, NEW JERSEY. A Service of the Radio Corporation of America